

BATTLETECH™

MISSIONS



Mission 3026-06: Get to the Choppa!
Rough Patch, Barlow's End, Federated Suns
September 31, 3026
Pilot Skill: 4-5

Okay boys, listen up! As you may or may not be aware, we've been tasked by our employers in the Federated Suns to help them extract some technological goodie they've been working on. It looks like the Snakes found out about it, and that's why they're here on Barlow's end, despite the fact that technically the two nations aren't actually at war right now. We've helped them get their widget this far – by protecting the so called “Achernar Proving Grounds” (which are nowhere near Achernar) this far to the edge of the nearest spaceport here in the city of Rough Patch. So now all we've got to do is get it the last kilometer or so to the waiting dropship. The Feds have established aerospace dominance, so the dropship should be safe once it's off the ground, but frankly, that's not our problem anyway. To make matters even easier, they've provided us with a few extra “Decoy” trucks. Don't worry, those trucks are expendable. Just get the one with the MacGuffin onto the dropship and we get paid.

Map: This mission takes place at a spaceport on the edge of town. This should be a standard 2x2 Battletech Missions map, with the spaceport on top, and wilderness maps at the bottom.



Recommended Maps:

- 1: DropPort1
- 2: DropPort 2
- 3: Foothills 2
- 4: 2018 Woodland

Setup: At the top left side of the map place a landed Leopard dropship. It should occupy 7 hexes (in the map above, it should be centered in hex 1102), facing in any direction that the PCs want. The Dragoons set up their forces on the map anywhere they like, but not within 24 hexes of the dropship. The PCs will enter from anywhere on the bottom edge on turn 1.

Special Rules

Three Card Monty: The Feds have provided four extra decoy trucks. At the start of the game the players should decide (in secret) which truck contains the MacGuffin and write it on a sheet of paper. These trucks are empty and have no effect on game outcome.

I give up! If the Combine/Dragon forces get a unit adjacent to a truck, and there are no friendly units within three hexes, then the truck is captured, and will be controlled by the GM. The heroes can regain control of the truck by having a unit adjacent to it while there are no Dragon/Combine units within three hexes. If a truck is captured it is immediately revealed as either the correct truck or a decoy. It can be recaptured by the heroes the same way.

Capture the MacGuffin: Initially, the Combine forces want to capture the device. However, if the heroes get any truck to within ten hexes of the dropship, or if the dropship fires on any combine unit, then they can attempt to destroy the MacGuffin by destroying the truck that it's in. If the truck is captured by the Dragoons, then the heroes may immediately fire on it to keep it out of enemy hands. The Dragoons can win the scenario by getting the truck off of the edge of the map that the PCs entered from.

Um. Guys? That's a DROPSHIP: The Leopard is a fully operational combat dropship, and counts as a combatant. It is immobile (-4) and a big target (-1), but on the other hand, shots fired by dropships are at a -1 bonus to hit due to their advanced targeting gear. To enter the dropship, a truck must spend a single movement point from the dropship's rear arc while facing the dropship.

The Dragoons can shoot at the dropship but do not want to spook the PCs into destroying the Macguffin. The Dragoons can not shoot at the dropship until they can shoot at the trucks. If the dropship is destroyed then the PCs cannot win a complete victory.

OPFOR

Name	#	Variant	Reference	BV (4/5)	Cost
Flatbed Truck	1	Armor	3067 pg. 7	117	N/A
Flatbed Truck	1	Armor	3067 pg. 7	117	N/A
Flatbed Truck	1	Armor	3067 pg. 7	117	N/A
Flatbed Truck	1	Armor	3060 pg. 7	117	N/A
Flatbed Truck	1	Armor	3067 pg. 7	117	N/A
Goblin Medium Tank	1		3039 pg. 97	555	N/A
Hornet	1	HNT-151	3039 pg 406	488	1,248,700
Firefly	1	FFL-4A	OK pg 33	831	2,203,500
Cicada	1	CDA-2A	3039 pg 178	659	3,705,217
Shadow Hawk	1	SHD-2H	3039 pg 465	1064	4,539,382
Merlin	1	MLN-1A	3058 pg 264	1218	4,960,000
Guillotine	1	GLT-4L	3039 pg 427	1400	6,062,483
Annihilator	1	ANH-1A	3050 IS pg 269	1434	7,696,666
Archer	1	ARC-2W	3039 pg 489	1338	6,447,873
Leopard Dropship	1	3025	Aerotech II	0	N/A

BVs are for regular (4/5) Pilots. Force bands BVs are adjusted for pilot skill

2000-2500 (2648 Total)

Annihilator ANH-1A (4/5), Goblin Medium Tank (4/5), Cicada CDA-2A (4/5)

2500-3000 (3292 Total)

Annihilator ANH-1A (4/5), Goblin Medium Tank (4/5), Cicada CDA-2A (4/5), Hornet HNT-151 (3/4)

3000-3500 (3856 Total)

Annihilator ANH-1A (4/5), Shadow Hawk SHD-2H (4/5), Cicada CDA-2A (3/4), Hornet HNT-151 (4/5)

3500-4000 (4372 Total)

Annihilator ANH-1A (4/5), Shadow Hawk SHD-2H (4/5), Goblin Medium Tank (4/5), Firefly FFL-4A (4/5), Hornet HNT-151 (4/5)

4000-4500 (4930 Total)

Annihilator ANH-1A (4/5), Shadow Hawk SHD-2H (4/5), Cicada CDA-2A (4/5), Goblin Medium Tank (4/5), Merlin MLN-1A (4/5)

4500-5000 (5546 Total)

Annihilator ANH-1A (4/5), Merlin MLN-1A (4/5), Shadow Hawk SHD-2H (3/4), Firefly FFL-4A (4/5), Cicada CDA-2A (4/5)

5000-5500 (6047 Total)

Annihilator ANH-1A (4/5), Guillotine GLT-4L (3/4), Shadow Hawk SHD-2H (4/5), Firefly FFL-4A (4/5), Cicada CDA-2A (3/4)

5500-6000 (6661 Total)

Annihilator ANH-1A (4/5), Guillotine GLT-4L (3/4), Merlin MLN-1A (4/5), Shadow Hawk SHD-2H (4/5), Firefly FFL-4A (3/4)

6000-6500 (7043 Total)

Annihilator ANH-1A (4/5), Archer ARC-2W (3/4), Shadow Hawk SHD-2H (3/4), Firefly FFL-4A (4/5), Merlin MLN-1A (3/4)

6500-7000 (7633 Total)

Annihilator ANH-1A (3/4), Archer ARC-2W (4/5), Guillotine GLT-4L (3/4), Shadow Hawk SHD-2H (4/5), Firefly FFL-4A (4/5), Cicada CDA-2A (4/5)

7000-7500 (8192 Total)

Annihilator ANH-1A (3/4), Archer ARC-2W (4/5), Guillotine GLT-4L (3/4), Shadow Hawk SHD-2H (4/5), Firefly FFL-4A (4/5), Merlin MLN-1A (4/5)

7500-8000 (8886 Total)

Annihilator ANH-1A (3/4), Archer ARC-2W (3/4), Guillotine GLT-4L (3/4), Shadow Hawk SHD-2H (4/5), Firefly FFL-4A (3/4), Merlin MLN-1A (4/5)

8000-8500 (9437 Total)

Annihilator ANH-1A (3/4), Archer ARC-2W (3/4), Guillotine GLT-4L (4/5), Shadow Hawk SHD-2H (3/4), Firefly FFL-4A (3/4), Merlin MLN-1A (4/5), Cicada CDA-2A (4/5)

8500-9000 (10009 Total)

Annihilator ANH-1A (3/4), Archer ARC-2W (3/4), Guillotine GLT-4L (3/4), Shadow Hawk SHD-2H (3/4), Firefly FFL-4A (4/5), Merlin MLN-1A (3/4), Cicada CDA-2A (4/5)

9000-9500 (10486 Total)

Annihilator ANH-1A (3/4), Archer ARC-2W (3/4), Guillotine GLT-4L (3/4), Shadow Hawk SHD-2H (3/4), Firefly FFL-4A (3/4), Merlin MLN-1A (3/4), Cicada CDA-2A (3/4)

Mission Objectives: The heroes want to get the truck with the MacGuffin onto the dropship by the end of the mission. If they get the MacGuffin onto the dropship, and it hasn't been destroyed by the end of that turn, then the heroes win immediately. Otherwise, if they have control of the truck with the MacGuffin, and are within 10 hexes of the dropship with no enemy units within six hexes at the end of the scenario, then they win. If the Dragoons get the truck off of the map or have control of it with no PC units within six hexes at the end of the scenario, then the Dragoons win. Otherwise, the scenario is a draw.

Award (C-Bills)	Mech Survived	Mech Severely Damaged	Mech Destroyed
PCs escape with the MacGuffin (Success)	450,000	350,000	200,000
Macguffin is destroyed or neither side controls it at the end of the scenario (Draw)	350,000	250,000	100,000
Dragoons escape with the MacGuffin (Failure)	150,000	100,000	50,000

Award (XP)	Pilot Survived	Pilot Killed
PCs escape with the MacGuffin (Success)	15	5
Macguffin is destroyed or neither side controls it at the end of the scenario (Draw)	15	5
Dragoons escape with the MacGuffin (Failure)	8	3
Opposing 'Mech/Combat Vehicle destroyed by party	+1	+1

Additional Rewards

Prototype "Freezers": □□□

Don't worry about that green stuff leaking out, It's perfectly safe

The Feds are extremely grateful for our heroes' aid. They've given each PC three prototype double-strength heat sinks (dubbed "Freezers" by the NAIS). These can be refitted to existing Battlemechs. The PC may replace up to three heat sinks in their 'mech. Double strength heat sinks take three critical slots instead of one, so the PC must mark two additional crit slots in the location with the heat sink. Only heat sinks on the record sheet can be replaced, and they cannot be moved.

Additionally, Prototype "Freezer" heat sinks are volatile. If a Freezer is hit it will explode for an additional point of internal structure damage (and an additional "Determine Critical Hit" roll). This does not count as an ammo explosion for purposes of pilot damage.

No 'mech may have more than three prototype Freezers at a time.

BATTLETECH

ARMOR DIAGRAM

GROUND VEHICLE RECORD SHEET

VEHICLE DATA

Type: Flatbed Truck (Armor)

Movement Points: **Tonnage:** 10
 Cruising: 5 **Tech Base:** Inner Sphere (Intro)
 Flank: 8 **Era:** Star League
Movement Type: Wheeled
Engine Type: I.C.E.

Weapons & Equipment Inventory (hexes)

Qty	Type	Loc	Dmg	Min	Sht	Med	Lng
4	Cargo (1 ton)	BD	[E]	--	--	--	--

CREW DATA

Crew: _____
Gunnery Skill: _____ **Driving Skill:** _____
 Commander Hit **+1** Driver Hit **+2**
Modifier to all Skill rolls Modifier to Driving Skill rolls

CRITICAL DAMAGE

Turret Locked Engine Hit
 Sensor Hits **+1 +2 +3** **D**
 Motive System Hits **+1 +2 +3**
 Stabilizers
 Front Left Right
 Rear

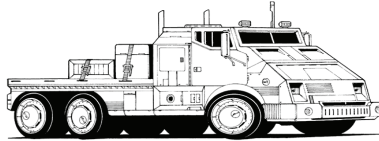
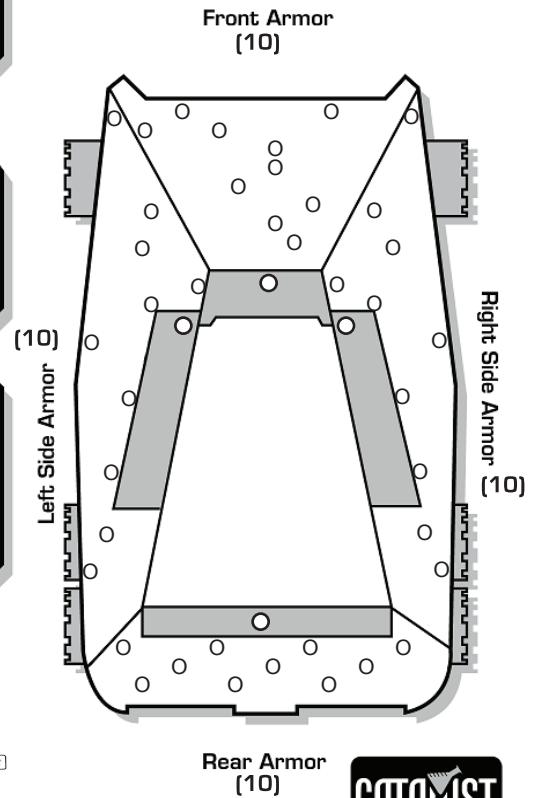

Cost: 47,250 C-bills BV: 117

© 2010 WizKids, Inc. Classic BattleTech, 'Mech and BattleMech are trademarks of WizKids, Inc. All rights reserved.
 Catalyst Game Labs and the Catalyst Game Labs logo are trademarks of InMediaRes Productions, LLC. Permission to photocopy for personal use.

GROUND COMBAT VEHICLE HIT LOCATION TABLE

2D6 Roll	ATTACK DIRECTION		
	FRONT	REAR	SIDES
2*	Front (critical)	Rear (critical)	Side (critical)
3	Front†	Rear†	Side†
4	Front†	Rear†	Side†
5	Right Side†	Left Side†	Front†
6	Front	Rear	Side
7	Front	Rear	Side
8	Front	Rear	Side (critical)*
9	Left Side†	Right Side†	Rear†
10	Turret	Turret	Turret
11	Turret	Turret	Turret
12*	Turret (critical)	Turret (critical)	Turret (critical)

*A result of 2 or 12 (or an 8 if the attack strikes the side) may inflict a critical hit on the vehicle. For each result of 2 or 12 (or 8 for side attacks), apply damage normally to the armor in that section. The attacking player then automatically rolls once on the Ground Combat Vehicle Critical Hits Table below (see *Combat*, p. 192 in *Total Warfare* for more information). A result of 12 on the Ground Combat Vehicles Hit Location Table may inflict critical hit against the turret; if the vehicle has no turret, a 12 indicates the chance of a critical hit on the side corresponding to the attack direction.
 †The vehicle may suffer motive system damage even if its armor remains intact. Apply damage normally to the armor in that section, but the attacking player also rolls once on the Motive System Damage Table at right (see *Combat*, p. 192 in *Total Warfare* for more information). Apply damage at the end of the phase in which the damage takes effect.
 ‡Side hits strike the side as indicated by the attack direction. For example, if an attack hits the right side, all Side results strike the right side armor. If the vehicle has no turret, a turret hit strikes the armor on the side attacked.

MOTIVE SYSTEM DAMAGE TABLE

2D6 Roll	EFFECT*
2-5	No effect.
6-7	Minor damage; +1 modifier to all Driving Skill Rolls
8-9	Moderate damage; -1 Cruising MP, +2 modifier to all Driving Skill Rolls
10-11	Heavy damage; only half Cruising MP (round fractions up), +3 modifier to all Driving Skill Rolls
12+	Major damage; no movement for the rest of the game. Vehicle is immobile.

Attack Direction Modifier:	Vehicle Type Modifiers:	
Hit from rear	Tracked, Naval	+0
Hit from the sides	Wheeled	+2
	Hovercraft, Hydrofoil	+3
	WIGE	+4

*All movement and Driving Skill Roll penalties are cumulative. However, each Driving Skill Roll modifier can only be applied once. For example, if a roll of 6-7 is made for a vehicle, inflicting a +1 modifier, that is the only time that particular +1 can be applied; a subsequent roll of 6-7 has no additional effect. This means the maximum Driving Skill Roll modifier that can be inflicted from the Motive System Damage Table is +6. If a unit's Cruising MP is reduced to 0, it cannot move for the rest of the game, but is not considered an immobile target. In addition, all motive system damage takes effect at the end of the phase in which the damage occurred. For example, if two units are attacking the same Combat Vehicle during the Weapon Attack Phase and the first unit inflicts motive system damage and rolls a 12, the -4 immobile target modifier would not apply for the second unit. However, the -4 modifier would take effect during the Physical Attack Phase. If a hover vehicle is rendered immobile while over a Depth 1 or deeper water hex, it sinks and is destroyed.

GROUND COMBAT VEHICLE CRITICAL HITS TABLE

2D6 Roll	LOCATION HIT			
	FRONT	SIDE	REAR	TURRET
2-5	No Critical Hit	No Critical Hit	No Critical Hit	No Critical Hit
6	Driver Hit	Cargo/Infantry Hit	Weapon Malfunction	Stabilizer
7	Weapon Malfunction	Weapon Malfunction	Cargo/Infantry Hit	Turret Jam
8	Stabilizer	Crew Stunned	Stabilizer	Weapon Malfunction
9	Sensors	Stabilizer	Weapon Destroyed	Turret Locks
10	Commander Hit	Weapon Destroyed	Engine Hit	Weapon Destroyed
11	Weapon Destroyed	Engine Hit	Ammunition**	Ammunition**
12	Crew Killed	Fuel Tank*	Fuel Tank*	Turret Blown Off

*If Combat Vehicle has ICE engine only. If Combat Vehicle has a fusion engine, treat this result as Engine Hit.
 **If Combat Vehicle carries no ammunition, treat this result as Weapon Destroyed.

© 2010 WizKids, Inc. Classic BattleTech, 'Mech and BattleMech are trademarks of WizKids, Inc. All rights reserved.
 Catalyst Game Labs and the Catalyst Game Labs logo are trademarks of InMediaRes Productions, LLC. Permission to photocopy for personal use.

BATTLETECH™

ARMOR DIAGRAM

GROUND VEHICLE RECORD SHEET

VEHICLE DATA

Type: Flatbed Truck (Armor)

Movement Points: **Tonnage:** 10
Cruising: 5 **Tech Base:** Inner Sphere (Intro)
Flank: 8 **Era:** Star League
Movement Type: Wheeled
Engine Type: I.C.E.

Weapons & Equipment Inventory (hexes)

Qty	Type	Loc	Dmg	Min	Sht	Med	Lng
4	Cargo (1 ton)	BD	[E]	--	--	--	--

CREW DATA

Crew: _____
Gunnery Skill: _____ **Driving Skill:** _____
Commander Hit [+1] **Driver Hit** [+2]
Modifier to all Skill rolls Modifier to Driving Skill rolls

CRITICAL DAMAGE

Turret Locked Engine Hit
Sensor Hits [+1] [+2] [+3] [D]
Motive System Hits [+1] [+2] [+3]
Stabilizers
Front **Left** **Right**
Rear

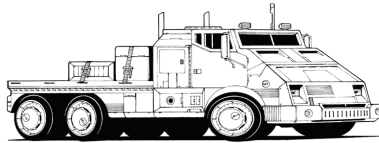
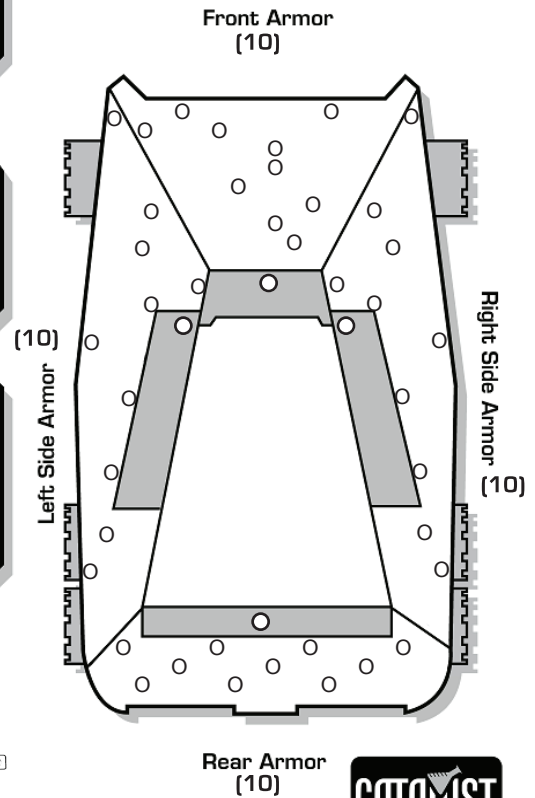

Cost: 47,250 C-bills BV: 117

© 2010 WizKids, Inc. Classic BattleTech, 'Mech and BattleMech are trademarks of WizKids, Inc. All rights reserved. Catalyst Game Labs and the Catalyst Game Labs logo are trademarks of InMediaRes Productions, LLC. Permission to photocopy for personal use.

GROUND COMBAT VEHICLE HIT LOCATION TABLE

2D6 Roll	ATTACK DIRECTION		
	FRONT	REAR	SIDES
2*	Front (critical)	Rear (critical)	Side (critical)
3	Front†	Rear†	Side†
4	Front†	Rear†	Side†
5	Right Side†	Left Side†	Front†
6	Front	Rear	Side
7	Front	Rear	Side
8	Front	Rear	Side (critical)*
9	Left Side†	Right Side†	Rear†
10	Turret	Turret	Turret
11	Turret	Turret	Turret
12*	Turret (critical)	Turret (critical)	Turret (critical)

*A result of 2 or 12 (or an 8 if the attack strikes the side) may inflict a critical hit on the vehicle. For each result of 2 or 12 (or 8 for side attacks), apply damage normally to the armor in that section. The attacking player then automatically rolls once on the Ground Combat Vehicle Critical Hits Table below (see *Combat*, p. 192 in *Total Warfare* for more information). A result of 12 on the Ground Combat Vehicles Hit Location Table may inflict critical hit against the turret; if the vehicle has no turret, a 12 indicates the chance of a critical hit on the side corresponding to the attack direction.
 †The vehicle may suffer motive system damage even if its armor remains intact. Apply damage normally to the armor in that section, but the attacking player also rolls once on the Motive System Damage Table at right (see *Combat*, p. 192 in *Total Warfare* for more information). Apply damage at the end of the phase in which the damage takes effect.
 ‡Side hits strike the side as indicated by the attack direction. For example, if an attack hits the right side, all Side results strike the right side armor. If the vehicle has no turret, a turret hit strikes the armor on the side attacked.

MOTIVE SYSTEM DAMAGE TABLE

2D6 Roll	EFFECT*
2-5	No effect.
6-7	Minor damage; +1 modifier to all Driving Skill Rolls
8-9	Moderate damage; -1 Cruising MP, +2 modifier to all Driving Skill Rolls
10-11	Heavy damage; only half Cruising MP (round fractions up), +3 modifier to all Driving Skill Rolls
12+	Major damage; no movement for the rest of the game. Vehicle is immobile.

Attack Direction Modifier:	Vehicle Type Modifiers:	
Hit from rear	Tracked, Naval	+0
Hit from the sides	Wheeled	+2
	Hovercraft, Hydrofoil	+3
	WIGE	+4

*All movement and Driving Skill Roll penalties are cumulative. However, each Driving Skill Roll modifier can only be applied once. For example, if a roll of 6-7 is made for a vehicle, inflicting a +1 modifier, that is the only time that particular +1 can be applied; a subsequent roll of 6-7 has no additional effect. This means the maximum Driving Skill Roll modifier that can be inflicted from the Motive System Damage Table is +6. If a unit's Cruising MP is reduced to 0, it cannot move for the rest of the game, but is not considered an immobile target. In addition, all motive system damage takes effect at the end of the phase in which the damage occurred. For example, if two units are attacking the same Combat Vehicle during the Weapon Attack Phase and the first unit inflicts motive system damage and rolls a 12, the -4 immobile target modifier would not apply for the second unit. However, the -4 modifier would take effect during the Physical Attack Phase. If a hover vehicle is rendered immobile while over a Depth 1 or deeper water hex, it sinks and is destroyed.

GROUND COMBAT VEHICLE CRITICAL HITS TABLE

2D6 Roll	LOCATION HIT			
	FRONT	SIDE	REAR	TURRET
2-5	No Critical Hit	No Critical Hit	No Critical Hit	No Critical Hit
6	Driver Hit	Cargo/Infantry Hit	Weapon Malfunction	Stabilizer
7	Weapon Malfunction	Weapon Malfunction	Cargo/Infantry Hit	Turret Jam
8	Stabilizer	Crew Stunned	Stabilizer	Weapon Malfunction
9	Sensors	Stabilizer	Weapon Destroyed	Turret Locks
10	Commander Hit	Weapon Destroyed	Engine Hit	Weapon Destroyed
11	Weapon Destroyed	Engine Hit	Ammunition**	Ammunition**
12	Crew Killed	Fuel Tank*	Fuel Tank*	Turret Blown Off

*If Combat Vehicle has ICE engine only. If Combat Vehicle has a fusion engine, treat this result as Engine Hit.
 **If Combat Vehicle carries no ammunition, treat this result as Weapon Destroyed.

© 2010 WizKids, Inc. Classic BattleTech, 'Mech and BattleMech are trademarks of WizKids, Inc. All rights reserved. Catalyst Game Labs and the Catalyst Game Labs logo are trademarks of InMediaRes Productions, LLC. Permission to photocopy for personal use.

BATTLETECH™

ARMOR DIAGRAM

GROUND VEHICLE RECORD SHEET

VEHICLE DATA

Type: Flatbed Truck (Armor)

Movement Points: **Tonnage:** 10
 Cruising: 5 **Tech Base:** Inner Sphere (Intro)
 Flank: 8 **Era:** Star League
Movement Type: Wheeled
Engine Type: I.C.E.

Weapons & Equipment Inventory (hexes)

Qty	Type	Loc	Dmg	Min	Sht	Med	Lng
4	Cargo (1 ton)	BD	[E]	--	--	--	--

CREW DATA

Crew: _____
Gunnery Skill: _____ **Driving Skill:** _____
 Commander Hit **+1** Driver Hit **+2**
Modifier to all Skill rolls Modifier to Driving Skill rolls

CRITICAL DAMAGE

Turret Locked Engine Hit
 Sensor Hits **+1 +2 +3** **D**
 Motive System Hits **+1 +2 +3**
 Stabilizers
 Front Left Right
 Rear

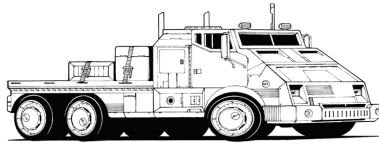
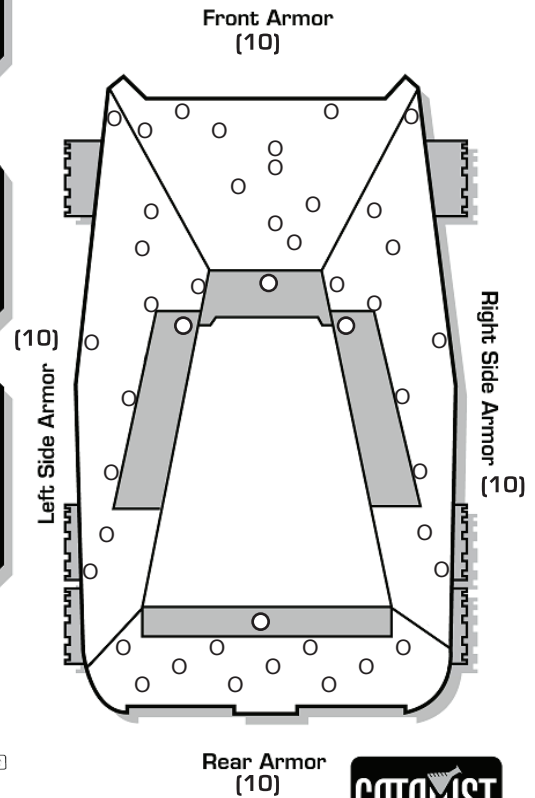

Cost: 47,250 C-bills BV: 117

© 2010 WizKids, Inc. Classic BattleTech, 'Mech and BattleMech are trademarks of WizKids, Inc. All rights reserved.
 Catalyst Game Labs and the Catalyst Game Labs logo are trademarks of InMediaRes Productions, LLC. Permission to photocopy for personal use.

GROUND COMBAT VEHICLE HIT LOCATION TABLE

2D6 Roll	ATTACK DIRECTION		
	FRONT	REAR	SIDES
2*	Front (critical)	Rear (critical)	Side (critical)
3	Front†	Rear†	Side†
4	Front†	Rear†	Side†
5	Right Side†	Left Side†	Front†
6	Front	Rear	Side
7	Front	Rear	Side
8	Front	Rear	Side (critical)*
9	Left Side†	Right Side†	Rear†
10	Turret	Turret	Turret
11	Turret	Turret	Turret
12*	Turret (critical)	Turret (critical)	Turret (critical)

*A result of 2 or 12 (or an 8 if the attack strikes the side) may inflict a critical hit on the vehicle. For each result of 2 or 12 (or 8 for side attacks), apply damage normally to the armor in that section. The attacking player then automatically rolls once on the Ground Combat Vehicle Critical Hits Table below (see *Combat*, p. 192 in *Total Warfare* for more information). A result of 12 on the Ground Combat Vehicles Hit Location Table may inflict critical hit against the turret; if the vehicle has no turret, a 12 indicates the chance of a critical hit on the side corresponding to the attack direction.
 †The vehicle may suffer motive system damage even if its armor remains intact. Apply damage normally to the armor in that section, but the attacking player also rolls once on the Motive System Damage Table at right (see *Combat*, p. 192 in *Total Warfare* for more information). Apply damage at the end of the phase in which the damage takes effect.
 ‡Side hits strike the side as indicated by the attack direction. For example, if an attack hits the right side, all Side results strike the right side armor. If the vehicle has no turret, a turret hit strikes the armor on the side attacked.

MOTIVE SYSTEM DAMAGE TABLE

2D6 Roll	EFFECT*
2-5	No effect.
6-7	Minor damage; +1 modifier to all Driving Skill Rolls
8-9	Moderate damage; -1 Cruising MP, +2 modifier to all Driving Skill Rolls
10-11	Heavy damage; only half Cruising MP (round fractions up), +3 modifier to all Driving Skill Rolls
12+	Major damage; no movement for the rest of the game. Vehicle is immobile.

Attack Direction Modifier:	Vehicle Type Modifiers:
Hit from rear	Tracked, Naval +0
Hit from the sides	Wheeled +2
	Hovercraft, Hydrofoil +3
	WIGE +4

*All movement and Driving Skill Roll penalties are cumulative. However, each Driving Skill Roll modifier can only be applied once. For example, if a roll of 6-7 is made for a vehicle, inflicting a +1 modifier, that is the only time that particular +1 can be applied; a subsequent roll of 6-7 has no additional effect. This means the maximum Driving Skill Roll modifier that can be inflicted from the Motive System Damage Table is +6. If a unit's Cruising MP is reduced to 0, it cannot move for the rest of the game, but is not considered an immobile target. In addition, all motive system damage takes effect at the end of the phase in which the damage occurred. For example, if two units are attacking the same Combat Vehicle during the Weapon Attack Phase and the first unit inflicts motive system damage and rolls a 12, the -4 immobile target modifier would not apply for the second unit. However, the -4 modifier would take effect during the Physical Attack Phase. If a hover vehicle is rendered immobile while over a Depth 1 or deeper water hex, it sinks and is destroyed.

GROUND COMBAT VEHICLE CRITICAL HITS TABLE

2D6 Roll	LOCATION HIT			
	FRONT	SIDE	REAR	TURRET
2-5	No Critical Hit	No Critical Hit	No Critical Hit	No Critical Hit
6	Driver Hit	Cargo/Infantry Hit	Weapon Malfunction	Stabilizer
7	Weapon Malfunction	Weapon Malfunction	Cargo/Infantry Hit	Turret Jam
8	Stabilizer	Crew Stunned	Stabilizer	Weapon Malfunction
9	Sensors	Stabilizer	Weapon Destroyed	Turret Locks
10	Commander Hit	Weapon Destroyed	Engine Hit	Weapon Destroyed
11	Weapon Destroyed	Engine Hit	Ammunition**	Ammunition**
12	Crew Killed	Fuel Tank*	Fuel Tank*	Turret Blown Off

*If Combat Vehicle has ICE engine only. If Combat Vehicle has a fusion engine, treat this result as Engine Hit.
 **If Combat Vehicle carries no ammunition, treat this result as Weapon Destroyed.

© 2010 WizKids, Inc. Classic BattleTech, 'Mech and BattleMech are trademarks of WizKids, Inc. All rights reserved.
 Catalyst Game Labs and the Catalyst Game Labs logo are trademarks of InMediaRes Productions, LLC. Permission to photocopy for personal use.

BATTLETECH™

ARMOR DIAGRAM

GROUND VEHICLE RECORD SHEET

VEHICLE DATA

Type: Flatbed Truck (Armor)

Movement Points: **Tonnage:** 10
Cruising: 5 **Tech Base:** Inner Sphere (Intro)
Flank: 8 **Era:** Star League
Movement Type: Wheeled
Engine Type: I.C.E.

Weapons & Equipment Inventory (hexes)

Qty	Type	Loc	Dmg	Min	Sht	Med	Lng
4	Cargo (1 ton)	BD	[E]	--	--	--	--

CREW DATA

Crew: _____
Gunnery Skill: _____ **Driving Skill:** _____
Commander Hit [+1] **Driver Hit** [+2]
Modifier to all Skill rolls Modifier to Driving Skill rolls

CRITICAL DAMAGE

Turret Locked Engine Hit
Sensor Hits [+1] [+2] [+3] [D]
Motive System Hits [+1] [+2] [+3]
Stabilizers
Front **Left** **Right**
Rear

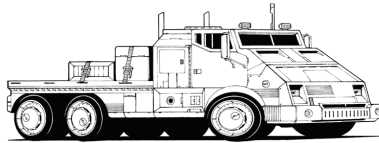
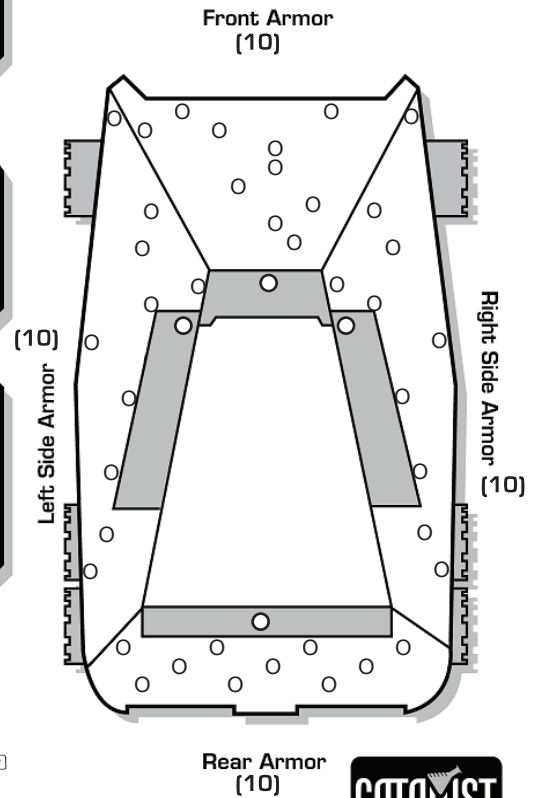

Cost: 47,250 C-bills BV: 117

© 2010 WizKids, Inc. Classic BattleTech, 'Mech and BattleMech are trademarks of WizKids, Inc. All rights reserved.
 Catalyst Game Labs and the Catalyst Game Labs logo are trademarks of InMediaRes Productions, LLC. Permission to photocopy for personal use.

GROUND COMBAT VEHICLE HIT LOCATION TABLE

2D6 Roll	ATTACK DIRECTION		
	FRONT	REAR	SIDES
2*	Front (critical)	Rear (critical)	Side (critical)
3	Front†	Rear†	Side†
4	Front†	Rear†	Side†
5	Right Side†	Left Side†	Front†
6	Front	Rear	Side
7	Front	Rear	Side
8	Front	Rear	Side (critical)*
9	Left Side†	Right Side†	Rear†
10	Turret	Turret	Turret
11	Turret	Turret	Turret
12*	Turret (critical)	Turret (critical)	Turret (critical)

*A result of 2 or 12 (or an 8 if the attack strikes the side) may inflict a critical hit on the vehicle. For each result of 2 or 12 (or 8 for side attacks), apply damage normally to the armor in that section. The attacking player then automatically rolls once on the Ground Combat Vehicle Critical Hits Table below (see *Combat*, p. 192 in *Total Warfare* for more information). A result of 12 on the Ground Combat Vehicles Hit Location Table may inflict critical hit against the turret; if the vehicle has no turret, a 12 indicates the chance of a critical hit on the side corresponding to the attack direction.
 †The vehicle may suffer motive system damage even if its armor remains intact. Apply damage normally to the armor in that section, but the attacking player also rolls once on the Motive System Damage Table at right (see *Combat*, p. 192 in *Total Warfare* for more information). Apply damage at the end of the phase in which the damage takes effect.
 ‡Side hits strike the side as indicated by the attack direction. For example, if an attack hits the right side, all Side results strike the right side armor. If the vehicle has no turret, a turret hit strikes the armor on the side attacked.

MOTIVE SYSTEM DAMAGE TABLE

2D6 Roll	EFFECT*
2-5	No effect.
6-7	Minor damage; +1 modifier to all Driving Skill Rolls
8-9	Moderate damage; -1 Cruising MP, +2 modifier to all Driving Skill Rolls
10-11	Heavy damage; only half Cruising MP (round fractions up), +3 modifier to all Driving Skill Rolls
12+	Major damage; no movement for the rest of the game. Vehicle is immobile.

Attack Direction Modifier:	Vehicle Type Modifiers:	
Hit from rear	Tracked, Naval	+0
Hit from the sides	Wheeled	+2
	Hovercraft, Hydrofoil	+3
	WIGE	+4

*All movement and Driving Skill Roll penalties are cumulative. However, each Driving Skill Roll modifier can only be applied once. For example, if a roll of 6-7 is made for a vehicle, inflicting a +1 modifier, that is the only time that particular +1 can be applied; a subsequent roll of 6-7 has no additional effect. This means the maximum Driving Skill Roll modifier that can be inflicted from the Motive System Damage Table is +6. If a unit's Cruising MP is reduced to 0, it cannot move for the rest of the game, but is not considered an immobile target. In addition, all motive system damage takes effect at the end of the phase in which the damage occurred. For example, if two units are attacking the same Combat Vehicle during the Weapon Attack Phase and the first unit inflicts motive system damage and rolls a 12, the -4 immobile target modifier would not apply for the second unit. However, the -4 modifier would take effect during the Physical Attack Phase. If a hover vehicle is rendered immobile while over a Depth 1 or deeper water hex, it sinks and is destroyed.

GROUND COMBAT VEHICLE CRITICAL HITS TABLE

2D6 Roll	LOCATION HIT			
	FRONT	SIDE	REAR	TURRET
2-5	No Critical Hit	No Critical Hit	No Critical Hit	No Critical Hit
6	Driver Hit	Cargo/Infantry Hit	Weapon Malfunction	Stabilizer
7	Weapon Malfunction	Weapon Malfunction	Cargo/Infantry Hit	Turret Jam
8	Stabilizer	Crew Stunned	Stabilizer	Weapon Malfunction
9	Sensors	Stabilizer	Weapon Destroyed	Turret Locks
10	Commander Hit	Weapon Destroyed	Engine Hit	Weapon Destroyed
11	Weapon Destroyed	Engine Hit	Ammunition**	Ammunition**
12	Crew Killed	Fuel Tank*	Fuel Tank*	Turret Blown Off

*If Combat Vehicle has ICE engine only. If Combat Vehicle has a fusion engine, treat this result as Engine Hit.
 **If Combat Vehicle carries no ammunition, treat this result as Weapon Destroyed.

© 2010 WizKids, Inc. Classic BattleTech, 'Mech and BattleMech are trademarks of WizKids, Inc. All rights reserved.
 Catalyst Game Labs and the Catalyst Game Labs logo are trademarks of InMediaRes Productions, LLC. Permission to photocopy for personal use.

BATTLETECH™

ARMOR DIAGRAM

GROUND VEHICLE RECORD SHEET

VEHICLE DATA

Type: Flatbed Truck (Armor)

Movement Points: **Tonnage:** 10
 Cruising: 5 **Tech Base:** Inner Sphere (Intro)
 Flank: 8 **Era:** Star League
Movement Type: Wheeled
Engine Type: I.C.E.

Weapons & Equipment Inventory (hexes)

Qty	Type	Loc	Dmg	Min	Sht	Med	Lng
4	Cargo (1 ton)	BD	[E]	--	--	--	--

CREW DATA

Crew: _____
 Gunnery Skill: _____ Driving Skill: _____
 Commander Hit **+1** Driver Hit **+2**
Modifier to all Skill rolls Modifier to Driving Skill rolls

CRITICAL DAMAGE

Turret Locked Engine Hit
 Sensor Hits **+1 +2 +3** **D**
 Motive System Hits **+1 +2 +3**
 Stabilizers
 Front Left Right
 Rear

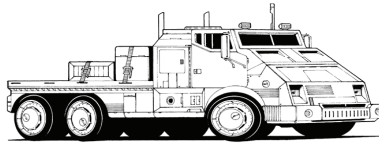
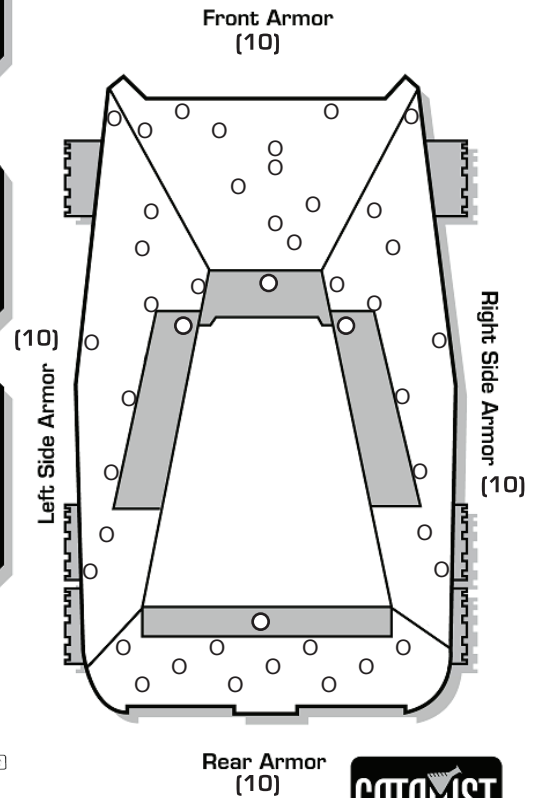

Cost: 47,250 C-bills BV: 117

© 2010 WizKids, Inc. Classic BattleTech, 'Mech and BattleMech are trademarks of WizKids, Inc. All rights reserved.
 Catalyst Game Labs and the Catalyst Game Labs logo are trademarks of InMediaRes Productions, LLC. Permission to photocopy for personal use.

GROUND COMBAT VEHICLE HIT LOCATION TABLE

2D6 Roll	ATTACK DIRECTION		
	FRONT	REAR	SIDES
2*	Front (critical)	Rear (critical)	Side (critical)
3	Front†	Rear†	Side†
4	Front†	Rear†	Side†
5	Right Side†	Left Side†	Front†
6	Front	Rear	Side
7	Front	Rear	Side
8	Front	Rear	Side (critical)*
9	Left Side†	Right Side†	Rear†
10	Turret	Turret	Turret
11	Turret	Turret	Turret
12*	Turret (critical)	Turret (critical)	Turret (critical)

*A result of 2 or 12 (or an 8 if the attack strikes the side) may inflict a critical hit on the vehicle. For each result of 2 or 12 (or 8 for side attacks), apply damage normally to the armor in that section. The attacking player then automatically rolls once on the Ground Combat Vehicle Critical Hits Table below (see *Combat*, p. 192 in *Total Warfare* for more information). A result of 12 on the Ground Combat Vehicles Hit Location Table may inflict critical hit against the turret; if the vehicle has no turret, a 12 indicates the chance of a critical hit on the side corresponding to the attack direction.
 †The vehicle may suffer motive system damage even if its armor remains intact. Apply damage normally to the armor in that section, but the attacking player also rolls once on the Motive System Damage Table at right (see *Combat*, p. 192 in *Total Warfare* for more information). Apply damage at the end of the phase in which the damage takes effect.
 ‡Side hits strike the side as indicated by the attack direction. For example, if an attack hits the right side, all Side results strike the right side armor. If the vehicle has no turret, a turret hit strikes the armor on the side attacked.

MOTIVE SYSTEM DAMAGE TABLE

2D6 Roll	EFFECT*
2-5	No effect.
6-7	Minor damage; +1 modifier to all Driving Skill Rolls
8-9	Moderate damage; -1 Cruising MP, +2 modifier to all Driving Skill Rolls
10-11	Heavy damage; only half Cruising MP (round fractions up), +3 modifier to all Driving Skill Rolls
12+	Major damage; no movement for the rest of the game. Vehicle is immobile.

Attack Direction Modifier:	Vehicle Type Modifiers:	
Hit from rear	Tracked, Naval	+0
Hit from the sides	Wheeled	+2
	Hovercraft, Hydrofoil	+3
	WIGE	+4

*All movement and Driving Skill Roll penalties are cumulative. However, each Driving Skill Roll modifier can only be applied once. For example, if a roll of 6-7 is made for a vehicle, inflicting a +1 modifier, that is the only time that particular +1 can be applied; a subsequent roll of 6-7 has no additional effect. This means the maximum Driving Skill Roll modifier that can be inflicted from the Motive System Damage Table is +6. If a unit's Cruising MP is reduced to 0, it cannot move for the rest of the game, but is not considered an immobile target. In addition, all motive system damage takes effect at the end of the phase in which the damage occurred. For example, if two units are attacking the same Combat Vehicle during the Weapon Attack Phase and the first unit inflicts motive system damage and rolls a 12, the -4 immobile target modifier would not apply for the second unit. However, the -4 modifier would take effect during the Physical Attack Phase. If a hover vehicle is rendered immobile while over a Depth 1 or deeper water hex, it sinks and is destroyed.

GROUND COMBAT VEHICLE CRITICAL HITS TABLE

2D6 Roll	LOCATION HIT			
	FRONT	SIDE	REAR	TURRET
2-5	No Critical Hit	No Critical Hit	No Critical Hit	No Critical Hit
6	Driver Hit	Cargo/Infantry Hit	Weapon Malfunction	Stabilizer
7	Weapon Malfunction	Weapon Malfunction	Cargo/Infantry Hit	Turret Jam
8	Stabilizer	Crew Stunned	Stabilizer	Weapon Malfunction
9	Sensors	Stabilizer	Weapon Destroyed	Turret Locks
10	Commander Hit	Weapon Destroyed	Engine Hit	Weapon Destroyed
11	Weapon Destroyed	Engine Hit	Ammunition**	Ammunition**
12	Crew Killed	Fuel Tank*	Fuel Tank*	Turret Blown Off

*If Combat Vehicle has ICE engine only. If Combat Vehicle has a fusion engine, treat this result as Engine Hit.
 **If Combat Vehicle carries no ammunition, treat this result as Weapon Destroyed.

© 2010 WizKids, Inc. Classic BattleTech, 'Mech and BattleMech are trademarks of WizKids, Inc. All rights reserved.
 Catalyst Game Labs and the Catalyst Game Labs logo are trademarks of InMediaRes Productions, LLC. Permission to photocopy for personal use.

BATTLETECH™

ARMOR DIAGRAM

GROUND VEHICLE RECORD SHEET

VEHICLE DATA

Type: Goblin Medium Tank

Movement Points: **Tonnage:** 45
Cruising: 4 **Tech Base:** Inner Sphere
Flank: 6 (Intro)
Movement Type: Tracked **Era:** Star League
Engine Type: I.C.E.

Weapons & Equipment Inventory (hexes)

Qty	Type	Loc	Dmg	Min	Sht	Med	Lng
1	Machine Gun	FR	2 [DB,AI]	—	1	2	3
1	Large Laser	T	8 [DE]	—	5	10	15

Cargo, Infantry (1 ton)

Ammo: (Machine Gun) 100

Cost: **BV:** 555

CREW DATA

Crew: _____
Gunnery Skill: _____ **Driving Skill:** _____
Commander Hit: +1 **Driver Hit:** +2
Modifier to all Skill rolls Modifier to Driving Skill rolls

CRITICAL DAMAGE

Turret Locked Engine Hit
Sensor Hits: +1 +2 +3 D
Motive System Hits: +1 +2 +3
Stabilizers:
Front: **Left:** **Right:**
Rear: **Turret:**

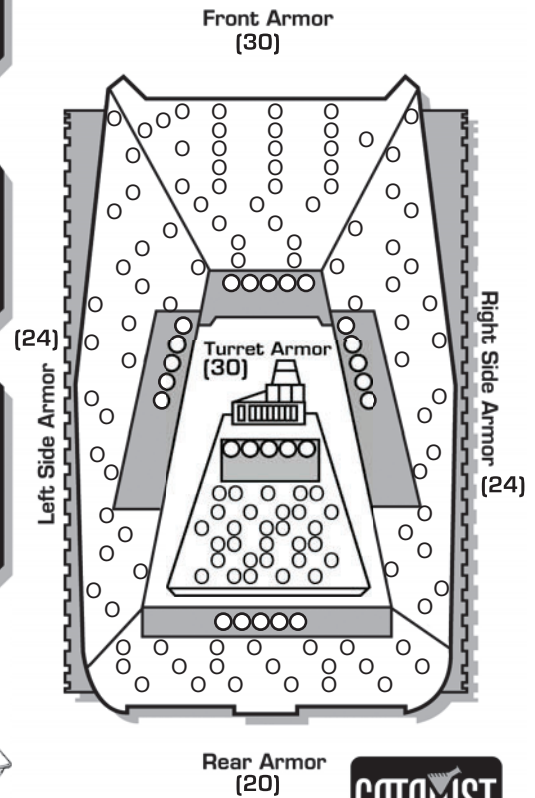
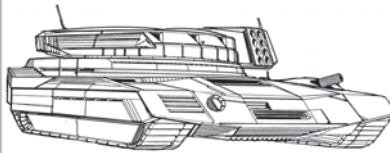

© 2011 The Topps Company, Inc. Classic BattleTech, 'Mech and BattleMech are trademarks of The Topps Company, Inc. All rights reserved. Catalyst Game Labs and the Catalyst Game Labs logo are trademarks of InMediaRes Productions, LLC. Permission to photocopy for personal use.

GROUND COMBAT VEHICLE HIT LOCATION TABLE

2D6 Roll	ATTACK DIRECTION		
	FRONT	REAR	SIDES
2*	Front (critical)	Rear (critical)	Side (critical)
3	Front †	Rear †	Side †
4	Front †	Rear †	Side †
5	Right Side †	Left Side †	Front †
6	Front	Rear	Side
7	Front	Rear	Side
8	Front	Rear	Side (critical)*
9	Left Side †	Right Side †	Rear †
10	Turret	Turret	Turret
11	Turret	Turret	Turret
12*	Turret (critical)	Turret (critical)	Turret (critical)

*A result of 2 or 12 (or an 8 if the attack strikes the side) may inflict a critical hit on the vehicle. For each result of 2 or 12 (or 8 for side attacks), apply damage normally to the armor in that section. The attacking player then automatically rolls once on the Ground Combat Vehicle Critical Hits Table below (see *Combat*, p. 192 in *Total Warfare* for more information). A result of 12 on the Ground Combat Vehicles Hit Location Table may inflict critical hit against the turret; if the vehicle has no turret, a 12 indicates the chance of a critical hit on the side corresponding to the attack direction.
†The vehicle may suffer motive system damage even if its armor remains intact. Apply damage normally to the armor in that section, but the attacking player also rolls once on the Motive System Damage Table at right (see *Combat*, p. 192 in *Total Warfare* for more information). Apply damage at the end of the phase in which the damage takes effect.
§Side hits strike the side as indicated by the attack direction. For example, if an attack hits the right side, all Side results strike the right side armor. If the vehicle has no turret, a turret hit strikes the armor on the side attacked.

MOTIVE SYSTEM DAMAGE TABLE

2D6 Roll	EFFECT*
2-5	No effect.
6-7	Minor damage; +1 modifier to all Driving Skill Rolls
8-9	Moderate damage; -1 Cruising MP, +2 modifier to all Driving Skill Rolls
10-11	Heavy damage; only half Cruising MP (round fractions up), +3 modifier to all Driving Skill Rolls
12+	Major damage; no movement for the rest of the game. Vehicle is immobile.

Attack Direction Modifier:	Vehicle Type Modifiers:	
Hit from rear	Tracked, Naval	+0
Hit from the sides	Wheeled	+2
	Hovercraft, Hydrofoil	+3
	WiGE	+4

*All movement and Driving Skill Roll penalties are cumulative. However, each Driving Skill Roll modifier can only be applied once. For example, if a roll of 6-7 is made for a vehicle, inflicting a +1 modifier, that is the only time that particular +1 can be applied; a subsequent roll of 6-7 has no additional effect. This means the maximum Driving Skill Roll modifier that can be inflicted from the Motive System Damage Table is +6. If a unit's Cruising MP is reduced to 0, it cannot move for the rest of the game, but is not considered an immobile target. In addition, all motive system damage takes effect at the end of the phase in which the damage occurred. For example, if two units are attacking the same Combat Vehicle during the Weapon Attack Phase and the first unit inflicts motive system damage and rolls a 12, the -4 immobile target modifier would not apply for the second unit. However, the -4 modifier would take effect during the Physical Attack Phase. If a hover vehicle is rendered immobile while over a Depth 1 or deeper water hex, it sinks and is destroyed.

GROUND COMBAT VEHICLE CRITICAL HITS TABLE

2D6 Roll	LOCATION HIT			
	FRONT	SIDE	REAR	TURRET
2-5	No Critical Hit	No Critical Hit	No Critical Hit	No Critical Hit
6	Driver Hit	Cargo/Infantry Hit	Weapon Malfunction	Stabilizer
7	Weapon Malfunction	Weapon Malfunction	Cargo/Infantry Hit	Turret Jam
8	Stabilizer	Crew Stunned	Stabilizer	Weapon Malfunction
9	Sensors	Stabilizer	Weapon Destroyed	Turret Locks
10	Commander Hit	Weapon Destroyed	Engine Hit	Weapon Destroyed
11	Weapon Destroyed	Engine Hit	Ammunition**	Ammunition**
12	Crew Killed	Fuel Tank*	Fuel Tank*	Turret Blown Off

*If Combat Vehicle has ICE engine only. If Combat Vehicle has a fusion engine, treat this result as Engine Hit.
**If Combat Vehicle carries no ammunition, treat this result as Weapon Destroyed.

© 2011 The Topps Company, Inc. Classic BattleTech, 'Mech and BattleMech are trademarks of The Topps Company, Inc. All rights reserved. Catalyst Game Labs and the Catalyst Game Labs logo are trademarks of InMediaRes Productions, LLC. Permission to photocopy for personal use.

CLASSIC BATTLETECH

'MECH RECORD SHEET

'MECH DATA

Type: **Hornet HNT-151**

Movement Points:

Walking: **5**

Running: **8**

Jumping: **5**

Tonnage: **20**

Tech Base: **Inner Sphere**
(Intro)

Era: **Star League**

WARRIOR DATA

Name:

Gunnery Skill:

Piloting Skill:

Hits Taken	1	2	3	4	5	6
Consciousness#	3	5	7	10	11	Dead

Weapons & Equipment Inventory (hexes)

Qty	Type	Loc	Ht	Dmg	Min	Sht	Med	Lng
1	Small Laser	LA	1	3 [DE]	-	1	2	3
1	Medium Laser	RA	3	5 [DE]	-	3	6	9
1	LRM 5	RT	2	1/MSI,C5/5 [M.C.S]	6	7	14	21

Cost: 1,248,700 CBills

BV: 488



ARMOR DIAGRAM

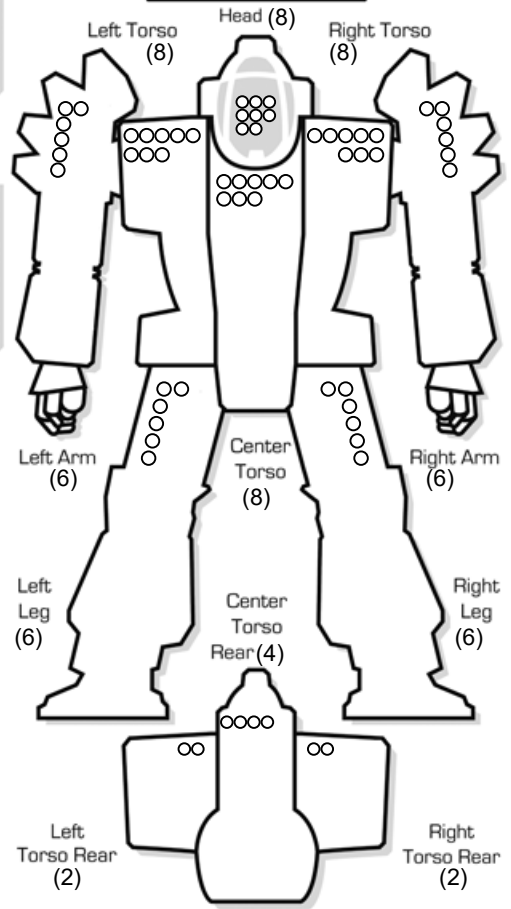

CRITICAL HIT TABLE

Left Arm

- Shoulder
 - Upper Arm Actuator
- 1-3
- Roll Again
 - Roll Again
 - Roll Again

Head

- Life Support
- Sensors
- Cockpit
- Roll Again
- Sensors
- Life Support

Right Arm

- Shoulder
 - Upper Arm Actuator
 - Medium Laser
- 1-3
- Roll Again
 - Roll Again
 - Roll Again

Center Torso

- Fusion Engine
 - Fusion Engine
 - Fusion Engine
- 1-3
- Gyro
 - Gyro
 - Gyro

- Roll Again
 - Roll Again
 - Roll Again
 - Roll Again
 - Roll Again
 - Roll Again
- 4-6

Left Torso

- Heat Sink
 - Heat Sink
 - Heat Sink
- 1-3
- LRM 5 Ammo (24)
 - Roll Again
 - Roll Again

- Gyro
 - Fusion Engine
 - Fusion Engine
 - Fusion Engine
 - JumpJets
 - Roll Again
- 4-6

Right Torso

- Heat Sink
 - Heat Sink
 - Heat Sink
 - LRM 5
 - Roll Again
 - Roll Again
- 1-3

Engine Hits ○○○○
Gyro Hits ○○
Sensor Hits ○○
Life Support ○

- Roll Again
 - Roll Again
 - Roll Again
 - Roll Again
 - Roll Again
 - Roll Again
- 4-6

Left Leg

- Hip
- Upper Leg Actuator
- Lower Leg Actuator
- Foot Actuator
- JumpJets
- JumpJets

Right Leg

- Hip
- Upper Leg Actuator
- Lower Leg Actuator
- Foot Actuator
- JumpJets
- JumpJets

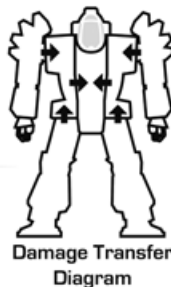

INTERNAL STRUCTURE DIAGRAM

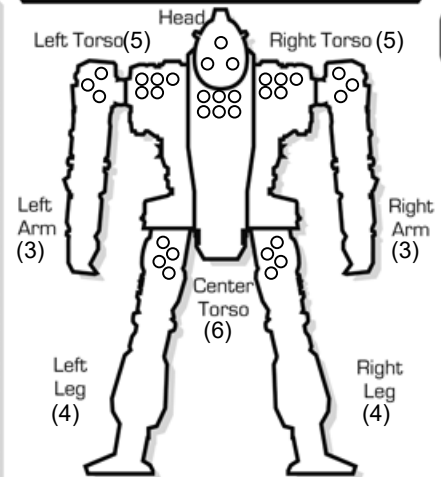

HEAT DATA

Heat Level*	Effects	Heat Sinks: 10 (10) Single
30	Shutdown	○
28	Ammo Exp. avoid on 8+	○
26	Shutdown, avoid on 10+	○
25	-5 Movement Points	○
24	+4 Modifier to Fire	○
23	Ammo Exp. avoid on 6+	○
22	Shutdown, avoid on 8+	○
20	-4 Movement Points	○
19	Ammo Exp. avoid on 4+	○
18	Shutdown, avoid on 6+	○
17	+3 Modifier to Fire	○
15	-3 Movement Points	○
14	Shutdown, avoid on 4+	○
13	+2 Modifier to Fire	○
10	-2 Movement Points	○
8	+1 Modifier to Fire	○
5	-1 Movement Points	○

Heat Scale

Overflow
30*
29
28*
27
26*
25*
24*
23*
22*
21
20*
19*
18*
17*
16
15*
14*
13*
12
11
10*
9
8*
7
6
5*
4
3
2
1
0

CLASSIC BATTLETECH

'MECH RECORD SHEET

'MECH DATA

Type: Firefly FFL-4A

Movement Points:

Walking: 5

Running: 8

Jumping: 4

Tonnage: 30

Tech Base: Inner Sphere
(Intro)

Era: Succession Wars

WARRIOR DATA

Name:

Gunnery Skill:

Piloting Skill:

Hits Taken	1	2	3	4	5	6
Consciousness#	3	5	7	10	11	Dead

Weapons & Equipment Inventory (hexes)

Qty	Type	Loc	Ht	Dmg	Min	Sht	Med	Lng
1	Medium Laser	CT	3	5 [DE]	-	3	6	9
1	Small Laser	CT	1	3 [DE]	-	1	2	3
1	Medium Laser	RT	3	5 [DE]	-	3	6	9
1	Medium Laser	LT	3	5 [DE]	-	3	6	9
1	Small Laser	RA	1	3 [DE]	-	1	2	3
1	Small Laser	LA	1	3 [DE]	-	1	2	3
1	Small Laser	LT	1	3 [DE]	-	1	2	3
1	LRM 5	RT	2	1/MS, C5/5	6	7	14	21

[M.C.S]

Cost: 2,203,500 CBills

BV: 831



ARMOR DIAGRAM

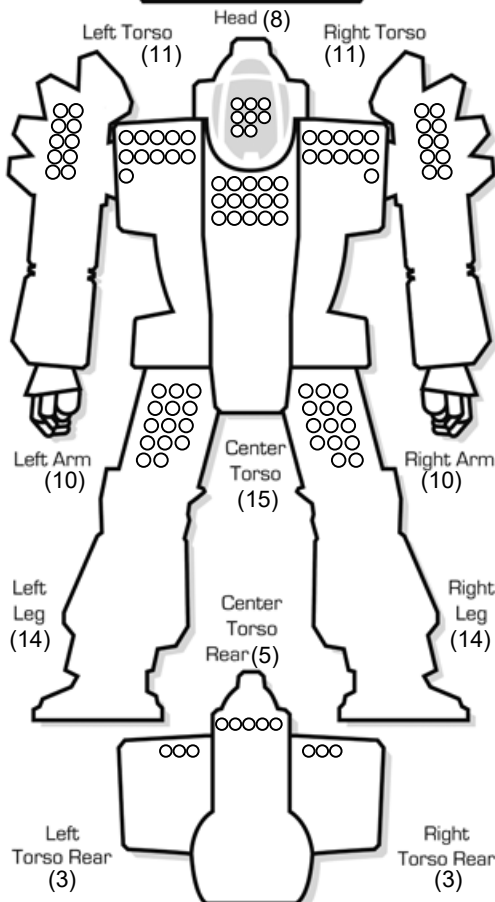

CRITICAL HIT TABLE

Left Arm

- Shoulder
 - Upper Arm Actuator
- 1-3
- Roll Again
 - Roll Again
 - Roll Again

Head

- Life Support
- Sensors
- Cockpit
- Roll Again
- Sensors
- Life Support

Right Arm

- Shoulder
 - Upper Arm Actuator
 - Small Laser
- 1-3
- Roll Again
 - Roll Again
 - Roll Again

Center Torso

- Fusion Engine
 - Fusion Engine
 - Fusion Engine
- 1-3
- Gyro
 - Gyro
 - Gyro

- Roll Again
 - Roll Again
 - Roll Again
 - Roll Again
 - Roll Again
 - Roll Again
- 4-6

Left Torso

- Heat Sink
 - Heat Sink
 - Medium Laser
 - Small Laser
- 1-3
- Roll Again
 - Roll Again

- Gyro
 - Fusion Engine
 - Fusion Engine
 - Fusion Engine
 - Medium Laser
 - Small Laser
- 4-6

Right Torso

- Heat Sink
 - Heat Sink
 - Medium Laser
 - LRM 5
 - LRM 5 Ammo (24)
 - Roll Again
- 1-3

Engine Hits ○○○○
Gyro Hits ○○
Sensor Hits ○○
Life Support ○

- Roll Again
 - Roll Again
 - Roll Again
 - Roll Again
 - Roll Again
 - Roll Again
- 4-6

- Roll Again
 - Roll Again
 - Roll Again
 - Roll Again
 - Roll Again
 - Roll Again
- 4-6

Left Leg

- Hip
- Upper Leg Actuator
- Lower Leg Actuator
- Foot Actuator
- JumpJets
- JumpJets

Right Leg

- Hip
- Upper Leg Actuator
- Lower Leg Actuator
- Foot Actuator
- JumpJets
- JumpJets

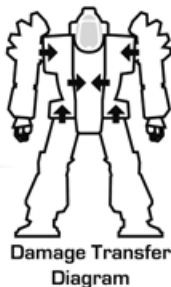

INTERNAL STRUCTURE DIAGRAM

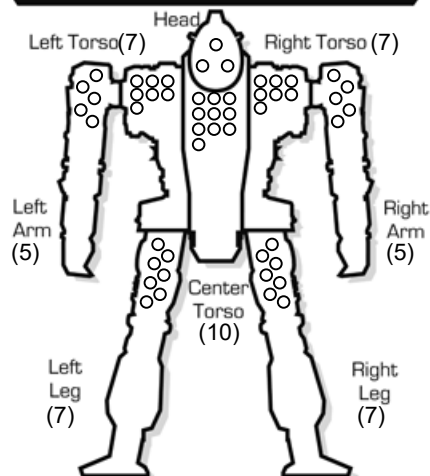

HEAT DATA

Heat Level*	Effects	Heat Sinks: 10 (10) Single
30	Shutdown	○
28	Ammo Exp. avoid on 8+	○
26	Shutdown, avoid on 10+	○
25	-5 Movement Points	○
24	+4 Modifier to Fire	○
23	Ammo Exp. avoid on 6+	○
22	Shutdown, avoid on 8+	○
20	-4 Movement Points	○
19	Ammo Exp. avoid on 4+	○
18	Shutdown, avoid on 6+	○
17	+3 Modifier to Fire	○
15	-3 Movement Points	○
14	Shutdown, avoid on 4+	○
13	+2 Modifier to Fire	○
10	-2 Movement Points	○
8	+1 Modifier to Fire	○
5	-1 Movement Points	○

Heat Scale

Overflow

30*
29
28*
27
26*
25*
24*
23*
22*
21
20*
19*
18*
17*
16
15*
14*
13*
12
11
10*
9
8*
7
6
5*
4
3
2
1
0

CLASSIC BATTLETECH

'MECH RECORD SHEET

'MECH DATA

Type: Cicada CDA-2A

Movement Points:

Walking: 8

Running: 12

Jumping: 0

Tonnage: 40

Tech Base: Inner Sphere
(Intro)

Era: Succession Wars

WARRIOR DATA

Name:

Gunnery Skill:

Piloting Skill:

Hits Taken	1	2	3	4	5	6
Consciousness#	3	5	7	10	11	Dead

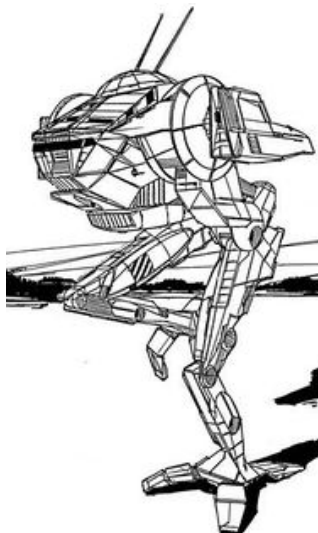

Weapons & Equipment Inventory (hexes)

Qty	Type	Loc	Ht	Dmg	Min	Sht	Med	Lng
1	Medium Laser	LT	3	5 [DE]	-	3	6	9
1	Medium Laser	RT	3	5 [DE]	-	3	6	9
1	Small Laser	CT	1	3 [DE]	-	1	2	3

Cost: 3,705,217 CBills

BV: 659

ARMOR DIAGRAM

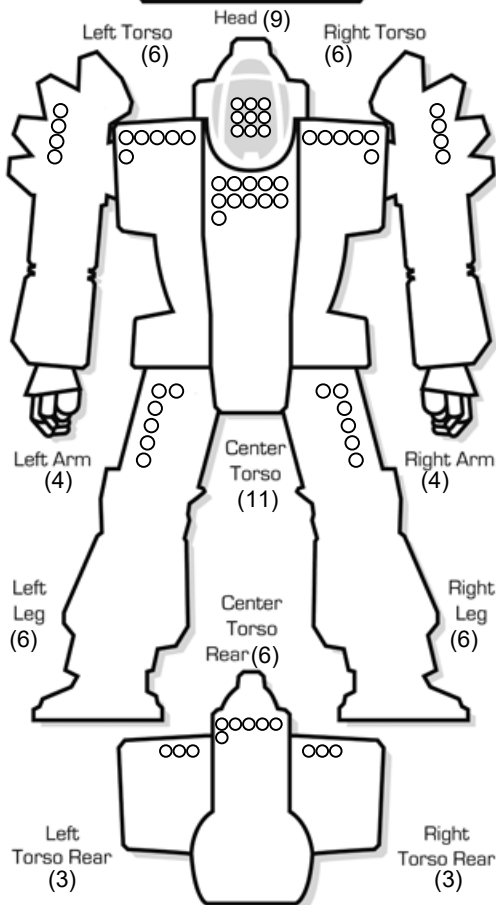

CRITICAL HIT TABLE

Left Arm

- Shoulder
 - Upper Arm Actuator
- 1-3
4. Roll Again
5. Roll Again
6. Roll Again

Head

- Life Support
- Sensors
- Cockpit
- Roll Again
- Sensors
- Life Support

Right Arm

- Shoulder
 - Upper Arm Actuator
- 1-3
4. Roll Again
5. Roll Again
6. Roll Again

Center Torso

- Fusion Engine
 - Fusion Engine
 - Fusion Engine
- 1-3
4. Gyro
5. Gyro
6. Gyro

- Roll Again
 - Roll Again
 - Roll Again
 - Roll Again
 - Roll Again
 - Roll Again
- 4-6

Left Torso

- Medium Laser
 - Roll Again
 - Roll Again
 - Roll Again
 - Roll Again
 - Roll Again
- 1-3

- Gyro
 - Fusion Engine
 - Fusion Engine
 - Fusion Engine
 - Small Laser
 - Roll Again
- 4-6

Right Torso

- Medium Laser
 - Roll Again
 - Roll Again
 - Roll Again
 - Roll Again
 - Roll Again
- 1-3

Engine Hits ○○○○
Gyro Hits ○○
Sensor Hits ○○
Life Support ○

- Roll Again
 - Roll Again
 - Roll Again
 - Roll Again
 - Roll Again
 - Roll Again
- 4-6

- Roll Again
 - Roll Again
 - Roll Again
 - Roll Again
 - Roll Again
 - Roll Again
- 4-6

Left Leg

- Hip
- Upper Leg Actuator
- Lower Leg Actuator
- Foot Actuator
- Roll Again
- Roll Again

Right Leg

- Hip
- Upper Leg Actuator
- Lower Leg Actuator
- Foot Actuator
- Roll Again
- Roll Again

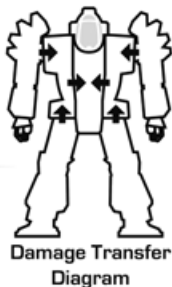

INTERNAL STRUCTURE DIAGRAM

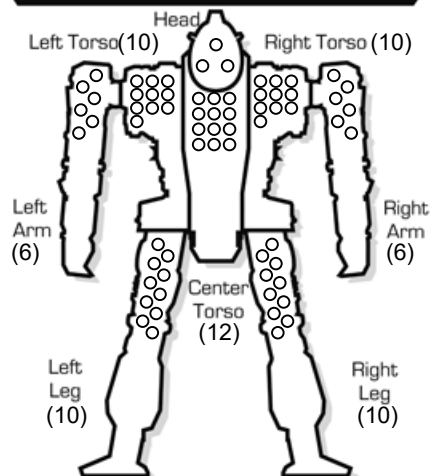

HEAT DATA

Heat Level*	Effects	Heat Sinks: 10 (10) Single
30	Shutdown	○
28	Ammo Exp. avoid on 8+	○
26	Shutdown, avoid on 10+	○
25	-5 Movement Points	○
24	+4 Modifier to Fire	○
23	Ammo Exp. avoid on 6+	○
22	Shutdown, avoid on 8+	○
20	-4 Movement Points	○
19	Ammo Exp. avoid on 4+	○
18	Shutdown, avoid on 6+	○
17	+3 Modifier to Fire	○
15	-3 Movement Points	○
14	Shutdown, avoid on 4+	○
13	+2 Modifier to Fire	○
10	-2 Movement Points	○
8	+1 Modifier to Fire	○
5	-1 Movement Points	○

Heat Scale

Overflow

30*
29
28*
27
26*
25*
24*
23*
22*
21
20*
19*
18*
17*
16
15*
14*
13*
12
11
10*
9
8*
7
6
5*
4
3
2
1
0

CLASSIC BATTLETECH

'MECH RECORD SHEET

'MECH DATA

Type: Shadow Hawk SHD-2H

Movement Points: Tonnage: 55
 Walking: 5 Tech Base: Inner Sphere (Intro)
 Running: 8 Era: Star League
 Jumping: 3

Weapons & Equipment Inventory (hexes)

Qty	Type	Loc	Ht	Dmg	Min	Sht	Med	Lng
1	SRM 2	H	2	2[Msl,C2/2 [M.C.S]	-	3	6	9
1	LRM 5	RT	2	1[Msl,C5/5 [M.C.S]	6	7	14	21
1	Autocannon/5	LT	1	5[DB,S]	3	6	12	18
1	Medium Laser	RA	3	5[DE]	-	3	6	9

Cost: 4,539,382 CBills BV: 1064

WARRIOR DATA

Name:
 Gunnery Skill: Piloting Skill:
 Hits Taken
 Consciousness#

1	2	3	4	5	6
3	5	7	10	11	Dead

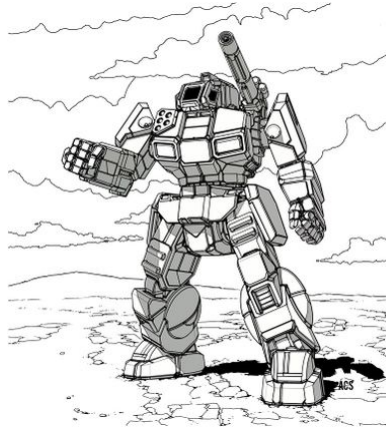

ARMOR DIAGRAM

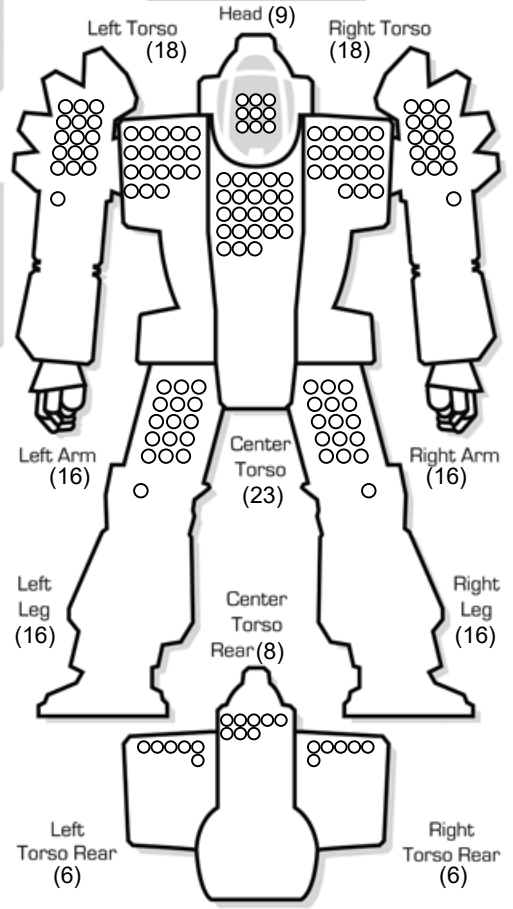

CRITICAL HIT TABLE

Left Arm

- Shoulder
- Upper Arm Actuator
- Lower Arm Actuator
- Hand Actuator
- Roll Again
- Roll Again

1-3

Head

- Life Support
- Sensors
- Cockpit
- SRM 2
- Sensors
- Life Support

Right Arm

- Shoulder
- Upper Arm Actuator
- Lower Arm Actuator
- Hand Actuator
- Medium Laser
- Roll Again

1-3

Center Torso

- Fusion Engine
- Fusion Engine
- Fusion Engine
- Gyro
- Gyro
- Gyro

1-3

Left Torso

- JumpJets
- Autocannon/5
- Autocannon/5
- Autocannon/5
- Autocannon/5
- AC/5 Ammo (20)

1-3

- Gyro
- Fusion Engine
- Fusion Engine
- Fusion Engine
- JumpJets
- SRM 2 Ammo (50)

4-6

Right Torso

- Heat Sink
- JumpJets
- LRM 5
- LRM 5 Ammo (24)
- Roll Again
- Roll Again

1-3

Engine Hits ○○○○
 Gyro Hits ○○
 Sensor Hits ○○
 Life Support ○

- Roll Again
- Roll Again
- Roll Again
- Roll Again
- Roll Again
- Roll Again

4-6

Left Leg

- Hip
- Upper Leg Actuator
- Lower Leg Actuator
- Foot Actuator
- Roll Again
- Roll Again

Right Leg

- Hip
- Upper Leg Actuator
- Lower Leg Actuator
- Foot Actuator
- Roll Again
- Roll Again

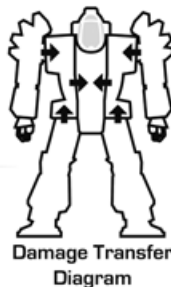

INTERNAL STRUCTURE DIAGRAM

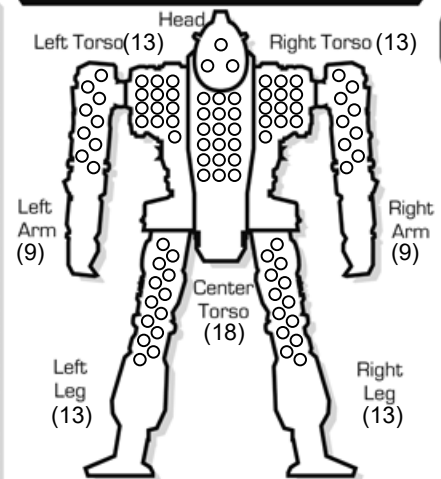

HEAT DATA

Heat Level*	Effects	Heat Sinks: 12 (12) Single
30	Shutdown	○ ○
28	Ammo Exp. avoid on 8+	○ ○ ○
26	Shutdown, avoid on 10+	○ ○ ○ ○
25	-5 Movement Points	○ ○ ○ ○ ○
24	+4 Modifier to Fire	○ ○ ○ ○ ○ ○
23	Ammo Exp. avoid on 6+	○ ○ ○ ○ ○ ○ ○
22	Shutdown, avoid on 8+	○ ○ ○ ○ ○ ○ ○ ○
20	-4 Movement Points	○ ○ ○ ○ ○ ○ ○ ○
19	Ammo Exp. avoid on 4+	○ ○ ○ ○ ○ ○ ○ ○ ○
18	Shutdown, avoid on 6+	○ ○ ○ ○ ○ ○ ○ ○ ○ ○
17	+3 Modifier to Fire	○ ○ ○ ○ ○ ○ ○ ○ ○ ○
15	-3 Movement Points	○ ○ ○ ○ ○ ○ ○ ○ ○ ○ ○
14	Shutdown, avoid on 4+	○ ○ ○ ○ ○ ○ ○ ○ ○ ○ ○ ○
13	+2 Modifier to Fire	○ ○ ○ ○ ○ ○ ○ ○ ○ ○ ○ ○ ○
10	-2 Movement Points	○ ○ ○ ○ ○ ○ ○ ○ ○ ○ ○ ○ ○ ○
8	+1 Modifier to Fire	○ ○ ○ ○ ○ ○ ○ ○ ○ ○ ○ ○ ○ ○ ○
5	-1 Movement Points	○ ○ ○ ○ ○ ○ ○ ○ ○ ○ ○ ○ ○ ○ ○ ○

Heat Scale

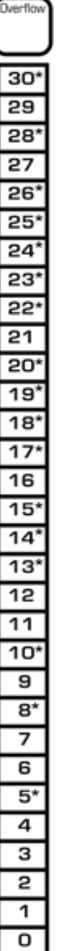

CLASSIC BATTLETECH

'MECH RECORD SHEET

'MECH DATA

Type: Guillotine GLT-4L

Movement Points:

Walking: 4

Running: 6

Jumping: 4

Tonnage: 70

Tech Base: Inner Sphere
(Intro)

Era: Succession Wars

WARRIOR DATA

Name:

Gunnery Skill:

Piloting Skill:

Hits Taken	1	2	3	4	5	6
Consciousness#	3	5	7	10	11	Dead

Weapons & Equipment Inventory (hexes)

Qty	Type	Loc	Ht	Dmg	Min	Sht	Med	Lng
1	Large Laser	LA	8	8 [DE]	-	5	10	15
1	Medium Laser	RA	3	5 [DE]	-	3	6	9
1	Medium Laser	RA	3	5 [DE]	-	3	6	9
1	Medium Laser	LT	3	5 [DE]	-	3	6	9
1	Medium Laser	RT	3	5 [DE]	-	3	6	9
1	SRM 6	CT	4	2/MSI,C2/6	-	3	6	9

[M.C.S.]

Cost: 6,062,483 CBills

BV: 1400

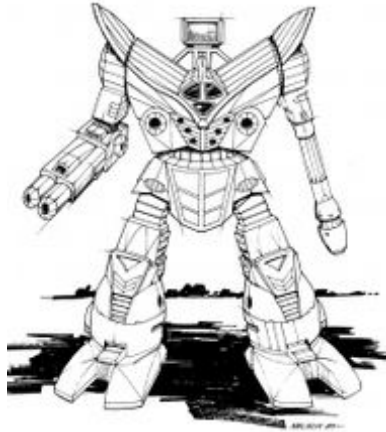

ARMOR DIAGRAM

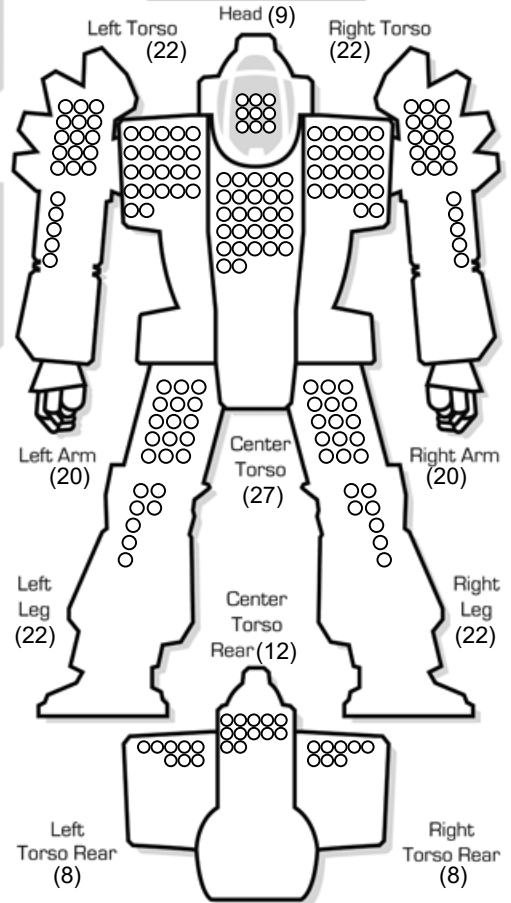

CRITICAL HIT TABLE

Left Arm

- Shoulder
- Upper Arm Actuator
- Large Laser
- Large Laser
- Roll Again
- Roll Again

1-3

Head

- Life Support
- Sensors
- Cockpit
- Roll Again
- Sensors
- Life Support

Right Arm

- Shoulder
- Upper Arm Actuator
- Lower Arm Actuator
- Medium Laser
- Medium Laser
- Roll Again

1-3

Center Torso

- Fusion Engine
- Fusion Engine
- Fusion Engine
- Gyro
- Gyro
- Gyro

1-3

Left Torso

- Heat Sink
- Heat Sink
- Heat Sink
- Heat Sink
- Heat Sink
- JumpJets

1-3

- Gyro
- Fusion Engine
- Fusion Engine
- Fusion Engine
- SRM 6
- SRM 6

4-6

Right Torso

- Heat Sink
- Heat Sink
- Heat Sink
- Heat Sink
- JumpJets
- Medium Laser

1-3

Engine Hits ○○○○

Gyro Hits ○○

Sensor Hits ○○

Life Support ○

- Medium Laser
- Roll Again
- Roll Again
- Roll Again
- Roll Again
- Roll Again

4-6

- SRM 6 Ammo (15)
- Roll Again
- Roll Again
- Roll Again
- Roll Again
- Roll Again

4-6

Left Leg

- Hip
- Upper Leg Actuator
- Lower Leg Actuator
- Foot Actuator
- Heat Sink
- JumpJets

Right Leg

- Hip
- Upper Leg Actuator
- Lower Leg Actuator
- Foot Actuator
- Heat Sink
- JumpJets

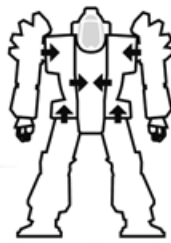

Damage Transfer Diagram

INTERNAL STRUCTURE DIAGRAM

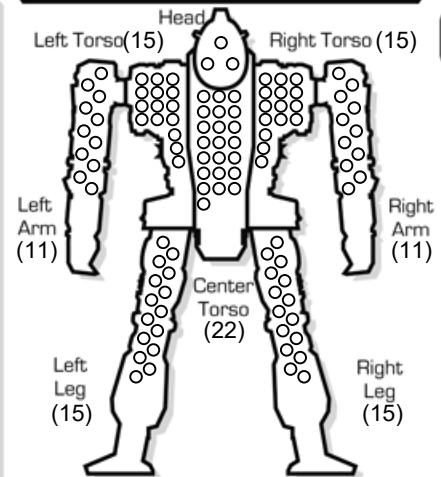

Heat Scale

Overflow

30*
29
28*
27
26*
25*
24*
23*
22*
21
20*
19*
18*
17*
16
15*
14*
13*
12
11
10*
9
8*
7
6
5*
4
3
2
1
0

HEAT DATA

Heat Level*	Effects	Heat Sinks: 22 (22) Single
30	Shutdown	○○○○
28	Ammo Exp. avoid on 8+	○○○○
26	Shutdown, avoid on 10+	○○○○
25	-5 Movement Points	○○○○
24	+4 Modifier to Fire	○○○○
23	Ammo Exp. avoid on 6+	○○○○
22	Shutdown, avoid on 8+	○○○○
20	-4 Movement Points	○○○○
19	Ammo Exp. avoid on 4+	○○○○
18	Shutdown, avoid on 6+	○○○○
17	+3 Modifier to Fire	○○○○
15	-3 Movement Points	○○○○
14	Shutdown, avoid on 4+	○○○○
13	+2 Modifier to Fire	○○○○
10	-2 Movement Points	○○○○
8	+1 Modifier to Fire	○○○○
5	-1 Movement Points	○○○○

CLASSIC BATTLETECH

'MECH RECORD SHEET

'MECH DATA

Type: Archer ARC-2W

Movement Points:

Walking: 4

Running: 6

Jumping: 0

Tonnage: 70

Tech Base: Inner Sphere
(Intro)

Era: Succession Wars

WARRIOR DATA

Name:

Gunnery Skill:

Piloting Skill:

Hits Taken	1	2	3	4	5	6
Consciousness#	3	5	7	10	11	Dead

Weapons & Equipment Inventory (hexes)

Qty	Type	Loc	Ht	Dmg	Min	Sht	Med	Lng
1	Medium Laser	LA	3	5 [DE]	-	3	6	9
1	Medium Laser	RA	3	5 [DE]	-	3	6	9
1	LRM 20	LT	6	1/Msl, C5/20	6	7	14	21
				[M.C.S]				
1	LRM 20	RT	6	1/Msl, C5/20	6	7	14	21
				[M.C.S]				
1	SRM 4	LT	3	2/Msl, C2/4	-	3	6	9
				[M.C.S]				
1	SRM 4	RT	3	2/Msl, C2/4	-	3	6	9
				[M.C.S]				

Cost: 6,447,873 CBills

BV: 1338



ARMOR DIAGRAM

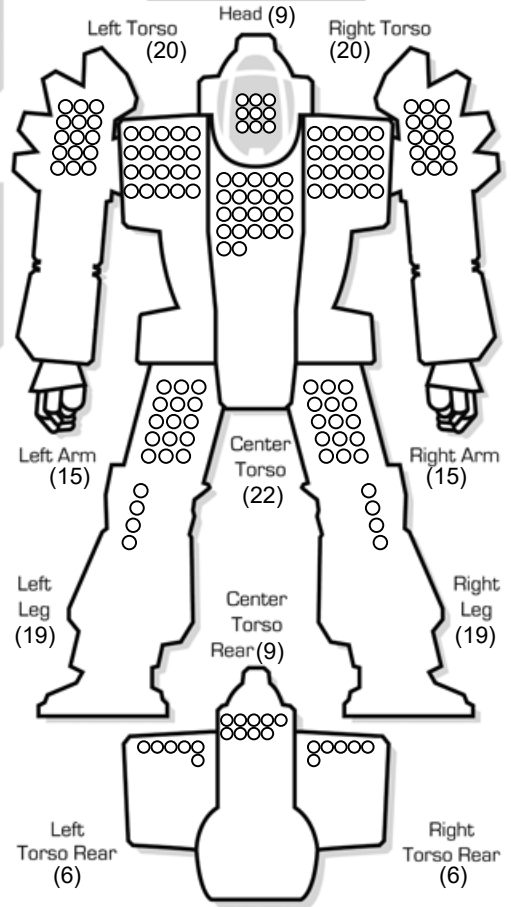

CRITICAL HIT TABLE

Left Arm

- Shoulder
- Upper Arm Actuator
- Lower Arm Actuator
- 1-3 Hand Actuator
- Medium Laser
- Roll Again

Head

- Life Support
- Sensors
- Cockpit
- Roll Again
- Sensors
- Life Support

Right Arm

- Shoulder
- Upper Arm Actuator
- Lower Arm Actuator
- 1-3 Hand Actuator
- Medium Laser
- Roll Again

Center Torso

- Roll Again
- Roll Again
- Roll Again
- 4-6 Gyro
- Gyro
- Gyro

- Roll Again
- Roll Again
- Roll Again
- 4-6 Roll Again
- Roll Again
- Roll Again

Left Torso

- LRM 20
- LRM 20
- LRM 20
- LRM 20
- LRM 20
- SRM 4

- Gyro
- Fusion Engine
- Fusion Engine
- 4-6 Fusion Engine
- SRM 4 Ammo (25)
- Roll Again

Right Torso

- LRM 20
- LRM 20
- LRM 20
- LRM 20
- LRM 20
- SRM 4

Engine Hits ○○○○
Gyro Hits ○○
Sensor Hits ○○
Life Support ○

- LRM 20 Ammo (6)
- LRM 20 Ammo (6)
- Roll Again
- Roll Again
- Roll Again
- Roll Again

Left Leg

- Hip
- Upper Leg Actuator
- Lower Leg Actuator
- Foot Actuator
- Roll Again
- Roll Again

Right Leg

- Hip
- Upper Leg Actuator
- Lower Leg Actuator
- Foot Actuator
- Roll Again
- Roll Again

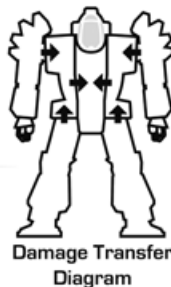

INTERNAL STRUCTURE DIAGRAM

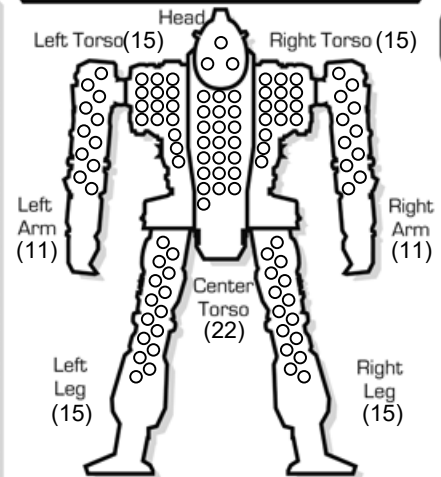

HEAT DATA

Heat Level*	Effects	Heat Sinks: 10 (10) Single
30	Shutdown	○
28	Ammo Exp. avoid on 8+	○
26	Shutdown, avoid on 10+	○
25	-5 Movement Points	○
24	+4 Modifier to Fire	○
23	Ammo Exp. avoid on 6+	○
22	Shutdown, avoid on 8+	○
20	-4 Movement Points	○
19	Ammo Exp. avoid on 4+	○
18	Shutdown, avoid on 6+	○
17	+3 Modifier to Fire	○
15	-3 Movement Points	○
14	Shutdown, avoid on 4+	○
13	+2 Modifier to Fire	○
10	-2 Movement Points	○
8	+1 Modifier to Fire	○
5	-1 Movement Points	○

Heat Scale

Overflow
30*
29
28*
27
26*
25*
24*
23*
22*
21
20*
19*
18*
17*
16
15*
14*
13*
12
11
10*
9
8*
7
6
5*
4
3
2
1
0

AEROTECH 2™

AERODYNE DROPSHIP RECORD SHEET

ARMOR DIAGRAM

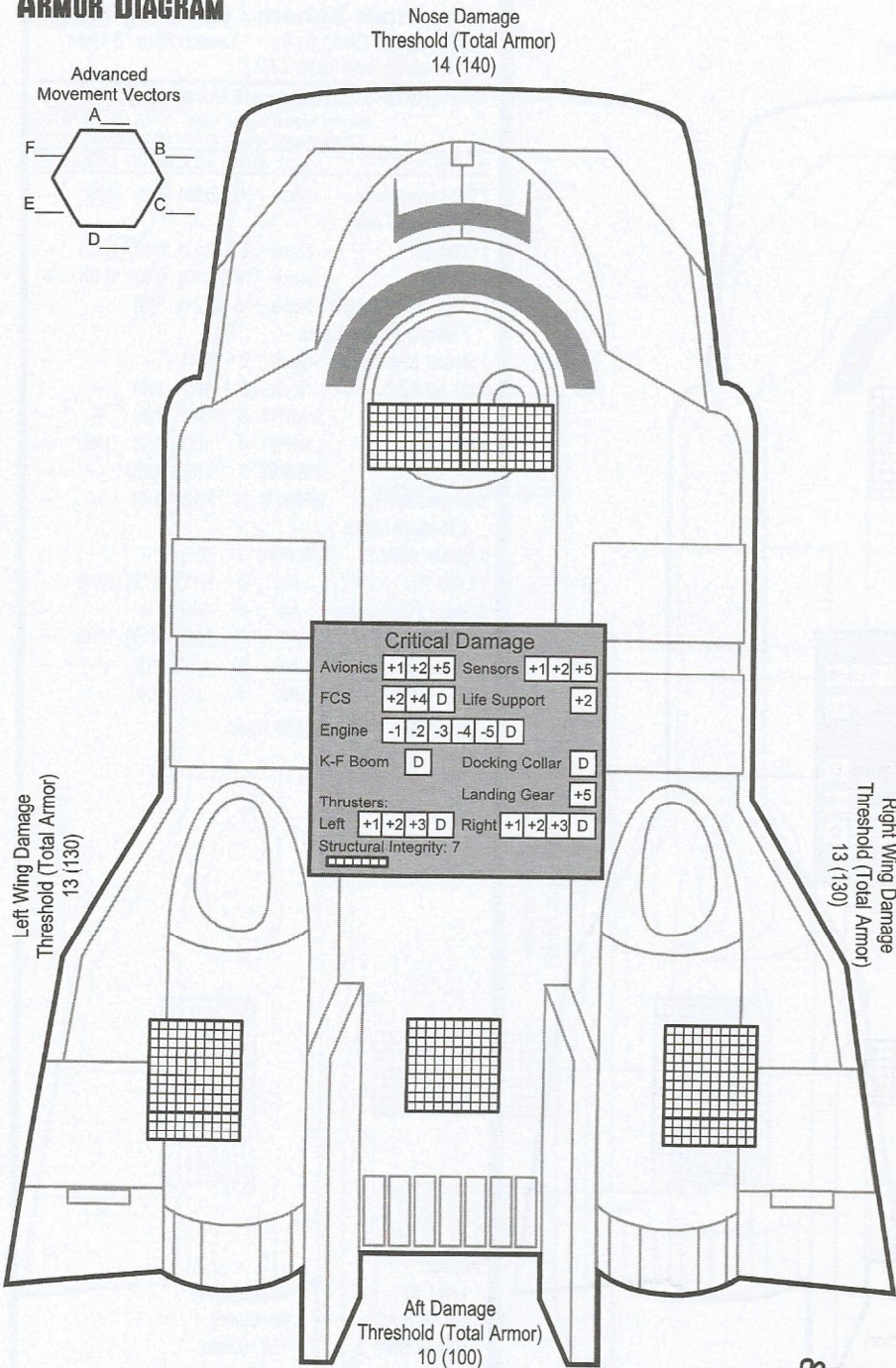

VESSEL DATA

Name: **Leopard (Obsolete Version)**
 Type: **Aerodyne DropShip**
 Mass: **1,900 tons**
 Thrust: Safe Thrust: **4** Max Thrust: **6**
 Tech: **Inner Sphere / Level 2 / 2537**
 Fighters/Small Craft: **2 / 0** Launch Rate: **4 / turn**
 Life Boats/Escape Pods: **0 / 2**

Weapons & Equipment Inventory:

Standard weapon ranges: (0-6) (7-12) (13-20) (21-30) (31-40) (41-50) (51-60) (61-70) (71-80) (81-90) (91-100)

Capital weapon ranges: (0-12) (13-24) (25-40) (41-60) (61-80) (81-100)

Bay	Loc	Heat	SRV	MRV	LRV
2 PPC	Nose	20	2(20)	2(20)	-
1 LRM 20	Nose	6	1(12)	1(12)	1(12)
3 Medium Laser	Nose	9	2(15)	-	-
1 LRM 20	LW/RW	6	1(12)	1(12)	1(12)
2 Large Laser	LW/RW	19	2(21)	2(16)	-
1 Medium Laser					
1 Large Laser	Aft	14	2(18)	1(8)	-
2 Medium Laser					

Cargo: Bay 1: BattleMechs (4) (4 doors)
 Bay 2: Fighters (2) (2 doors)
 Bay 3: Cargo (14 Tons)

Ammo:
 LRM 20 36 rounds

Total Heat Sinks: 80 Single
Heat Generation per Arc: (99 Total)

Nose: 35 Left/Right Wing: 25 x 2
 Left/Right Wing (Aft): 0 x 2 Aft: 14

Crew Data

Gunnery Skill: _____ Piloting Skill: _____

Hits Taken	1	2	3	4	5	6
Modifier	+1	+2	+3	+4	+5	Incap

Crew: 9 Passengers: 0 Other: 12

Battle Value: 2,579

Cost: 171,358,128

Velocity Record		1	2	3	4	5	6	7	8	9	10	11	12	13	14	15	16	17	18	19	20
Turn #																					
Thrust																					
Velocity																					
Effective Velocity																					
Altitude Level																					
Fuel Pts	5,480																				

BATTLETECH™

MISSIONS



Character _____ Player _____ Cert _____

Mission: 3026-06

Get to the Choppa!

Rough Patch, Barlow's End, Federated Suns

September 31, 3026

Mission Results

- PCs escape with the MacGuffin (Success)
- Macguffin is destroyed or neither side controls it at the end of the scenario (Draw)
- Dragoons escape with the MacGuffin (Failure)
- Opposing 'Mech/Combat Vehicle destroyed by party (+1 XP)

Mech Status

- Mech Survived
- Mech Severely Damaged
- Mech Destroyed

Pilot Status

- Pilot Survived
- Pilot Killed

C-Bill Reward _____ **XP Reward** _____

Salvaged Mechs

- Hornet HNT-151 (1,248,700 C-Bills)
- Firefly FFL-4A (2,203,500 C-Bills)
- Cicada CDA-2A (3,705,217 C-Bills)
- Shadow Hawk SHD-2H (4,539,382 C-Bills)
- Merlin MLN-1A (4,960,000 C-Bills)
- Guillotine GLT-4L (6,062,483 C-Bills)
- Annihilator ANH-1A (7,696,666 C-Bills)
- Archer ARC-2W (6,447,873 C-Bills)

Additional Rewards

Prototype "Freezers":

Don't worry about that green stuff leaking out, it's perfectly safe

The Feds are extremely grateful for our heroes' aid. They've given each PC three prototype double-strength heat sinks (dubbed "Freezers" by the NAIS). These can be refitted to existing Battlemechs. The PC may replace up to three heat sinks in their 'mech. Double strength heat sinks take three critical slots instead of one, so the PC must mark two additional crit slots in the location with the heat sink. Only heat sinks on the record sheet can be replaced, and they cannot be moved.

Additionally, Prototype "Freezer" heat sinks are volatile. If a Freezer is hit it will explode for an additional point of internal structure damage (and an additional "Determine Critical Hit" roll). This does not count as an ammo explosion for purposes of pilot damage.

No 'mech may have more than three prototype Freezers at a time.

GM Signature _____ **Game Date** _____

BATTLETECH™

MISSIONS



Mission: 3026-06 Debrief

Get to the Choppa!

Rough Patch, Barlow's End, Federated Suns

September 31, 3026

You find yourself standing (still in your 'mechs) around the drop port in Rough Patch. You can still see the vapor trails from the retreating dropship with the MacGuffin safely tucked away. The remaining Dragoons' forces have also left the area, having lost all interest in you as soon as their primary objective had escaped.

"So, what the hell was that, anyway?" you ask Dr. Burton, one of the Fed scientists who stayed behind. "Why did the snakes want it so bad? Was it some kind of fancy 'mech weapon or something?"

"Nope" he starts. There's a pause while he clearly thinks about what he's saying, then starts again. "Hell, I might as well tell you, the bad guys already know about it, who are you going to tell? But if you do, you didn't hear it from me. It's a 'Jump Stabilizer.' highly experimental stuff. Basically, you know how Jumpships can only jump about, oh, 30 Light Years or so? Well, it has to do with quantum instabilities in the K/F field. Beyond 30 Light years the field begins to break down and the odds of misjumps increase exponentially. If these guys can make the stabilizer work, they can increase by perhaps as much as a factor of two the safe range of a jump. The military and civilian uses would be incredible. This is stuff even the Star League never imagined"

It's kinda a neat story, actually. You get warm fuzzies just thinking that you might have just saved the technology that could halve the time it takes to cross interstellar empires. Of course, then you think of how terrible it could be. With that sort of technology, the Feds could hit worlds much farther into the Combine (or the Confederation). Border zones would need to be twice as deep, making them much harder to defend. It's actually a bit scary, as well as pretty cool.

Too bad it's all a crock.

You ask Scotty, the Lancers' chief tech about it when you get back to the dropship.

"Hey, did you ever hear about the Manhattan Project? It was the invention of the first atomic weapon by the former North American power called 'USA'. Anyway, it was this top secret project involving hundreds of scientists. Because they didn't want their enemies the Germans to find out what they were doing, they spread a bunch of misinformation about what they were working on – to the extent that the scientists even told their wives that they were 'dehydrogenating water' – to make it easier to carry on the battlefield. Then all they'd need to do is add Hydrogen and – poof, good clean, drinkable water."

Okay, makes sense so far...

"Well, obviously that's stupid. But it sounded good. Same goes with the notion of 'removing instabilities in the K/F field'. The limiting factor of a K/F jump isn't instability or anything like that –

it's about the way that mass affects the shape of spacetime. You calculate the energy required as a function of the mass of the jumping object and an exponential factor of the distance jumped. There's a weird cliff effect at around 30 Light Years. When the mass is negligible, like in a Hyperpulse, then the distance can be much higher. But when the mass is as big as a jumpship, well..."

Bummer.

"Anyway, whatever it was they were making, it's unlikely it had anything to do with jumpships. My guess? They told you a very specific story to see if it gets back to them. Then they'll know they can't trust you. I wouldn't go repeating that story if I were you. You know, unless at some point the Feds really do invent a double-strength jump drive. Then you can tell everyone how instrumental you were in its invention. But I wouldn't hold my breath..."

Well, even if you weren't responsible for the survival of the single greatest technological advance in your lifetime, at least you've got a story about dehydrating water you can tell your buddies back at Barlow's Beginning.

"Oh, hey!" Scotty interrupts you before you can leave. "So, whatever it was, the Feds really wanted it. You see those trucks out there? They've delivered a bunch of toys for you to play with. They're called 'Freezers', and they're the NAIS's attempt at replicating the double strength heat sinks that the Star League was famous for. There's enough for each of you to refit up to three heat sinks on your 'mechs. They're much bulkier than regular heat sinks, but they weigh the same and dissipate twice as much heat. Only downside if they're chock full of some really nasty stuff. Makes the Ethylene Glycol the regular ones are fulla look like mother's milk, if you know what I mean...Anyway, it looks like the Combine is bugging out, so I should have plenty of time to mount 'em wherever you want before our next mission. Just lemme know"

BATTLETECH™



MISSIONS

Character _____ Player _____ Cert _____

Mission: 3026-06

Get to the Choppa!

Rough Patch, Barlow's End, Federated Suns

September 31, 3026

Mission Results

- PCs escape with the MacGuffin (Success)
- Macguffin is destroyed or neither side controls it at the end of the scenario (Draw)
- Dragoons escape with the MacGuffin (Failure)
- Opposing 'Mech/Combat Vehicle destroyed by party (+1 XP)

Mech Status

- Mech Survived
- Mech Severely Damaged
- Mech Destroyed

Pilot Status

- Pilot Survived
- Pilot Killed

C-Bill Reward _____ **XP Reward** _____

Salvaged Mechs

- Hornet HNT-151 (1,248,700 C-Bills)
- Firefly FFL-4A (2,203,500 C-Bills)
- Cicada CDA-2A (3,705,217 C-Bills)
- Shadow Hawk SHD-2H (4,539,382 C-Bills)
- Merlin MLN-1A (4,960,000 C-Bills)
- Guillotine GLT-4L (6,062,483 C-Bills)
- Annihilator ANH-1A (7,696,666 C-Bills)
- Archer ARC-2W (6,447,873 C-Bills)

Additional Rewards

Prototype "Freezers":

Don't worry about that green stuff leaking out, it's perfectly safe

The Feds are extremely grateful for our heroes' aid. They've given each PC three prototype double-strength heat sinks (dubbed "Freezers" by the NAIS). These can be refitted to existing Battlemechs. The PC may replace up to three heat sinks in their 'mech. Double strength heat sinks take three critical slots instead of one, so the PC must mark two additional crit slots in the location with the heat sink. Only heat sinks on the record sheet can be replaced, and they cannot be moved.

Additionally, Prototype "Freezer" heat sinks are volatile. If a Freezer is hit it will explode for an additional point of internal structure damage (and an additional "Determine Critical Hit" roll). This does not count as an ammo explosion for purposes of pilot damage.

No 'mech may have more than three prototype Freezers at a time.

GM Signature _____ **Game Date** _____

BATTLETECH™

MISSIONS



Mission: 3026-06 Debrief

Get to the Choppa!

Rough Patch, Barlow's End, Federated Suns

September 31, 3026

You find yourself standing (still in your 'mechs) around the drop port in Rough Patch. You can still see the vapor trails from the retreating dropship with the MacGuffin safely tucked away. The remaining Dragoons' forces have also left the area, having lost all interest in you as soon as their primary objective had escaped.

"So, what the hell was that, anyway?" you ask Dr. Burton, one of the Fed scientists who stayed behind. "Why did the snakes want it so bad? Was it some kind of fancy 'mech weapon or something?"

"Nope" he starts. There's a pause while he clearly thinks about what he's saying, then starts again. "Hell, I might as well tell you, the bad guys already know about it, who are you going to tell? But if you do, you didn't hear it from me. It's a 'Jump Stabilizer.' highly experimental stuff. Basically, you know how Jumpships can only jump about, oh, 30 Light Years or so? Well, it has to do with quantum instabilities in the K/F field. Beyond 30 Light years the field begins to break down and the odds of misjumps increase exponentially. If these guys can make the stabilizer work, they can increase by perhaps as much as a factor of two the safe range of a jump. The military and civilian uses would be incredible. This is stuff even the Star League never imagined"

It's kinda a neat story, actually. You get warm fuzzies just thinking that you might have just saved the technology that could halve the time it takes to cross interstellar empires. Of course, then you think of how terrible it could be. With that sort of technology, the Feds could hit worlds much farther into the Combine (or the Confederation). Border zones would need to be twice as deep, making them much harder to defend. It's actually a bit scary, as well as pretty cool.

Too bad it's all a crock.

You ask Scotty, the Lancers' chief tech about it when you get back to the dropship.

"Hey, did you ever hear about the Manhattan Project? It was the invention of the first atomic weapon by the former North American power called 'USA'. Anyway, it was this top secret project involving hundreds of scientists. Because they didn't want their enemies the Germans to find out what they were doing, they spread a bunch of misinformation about what they were working on – to the extent that the scientists even told their wives that they were 'dehydrogenating water' – to make it easier to carry on the battlefield. Then all they'd need to do is add Hydrogen and – poof, good clean, drinkable water."

Okay, makes sense so far...

"Well, obviously that's stupid. But it sounded good. Same goes with the notion of 'removing instabilities in the K/F field'. The limiting factor of a K/F jump isn't instability or anything like that –

it's about the way that mass affects the shape of spacetime. You calculate the energy required as a function of the mass of the jumping object and an exponential factor of the distance jumped. There's a weird cliff effect at around 30 Light Years. When the mass is negligible, like in a Hyperpulse, then the distance can be much higher. But when the mass is as big as a jumpship, well..."

Bummer.

"Anyway, whatever it was they were making, it's unlikely it had anything to do with jumpships. My guess? They told you a very specific story to see if it gets back to them. Then they'll know they can't trust you. I wouldn't go repeating that story if I were you. You know, unless at some point the Feds really do invent a double-strength jump drive. Then you can tell everyone how instrumental you were in its invention. But I wouldn't hold my breath..."

Well, even if you weren't responsible for the survival of the single greatest technological advance in your lifetime, at least you've got a story about dehydrating water you can tell your buddies back at Barlow's Beginning.

"Oh, hey!" Scotty interrupts you before you can leave. "So, whatever it was, the Feds really wanted it. You see those trucks out there? They've delivered a bunch of toys for you to play with. They're called 'Freezers', and they're the NAIS's attempt at replicating the double strength heat sinks that the Star League was famous for. There's enough for each of you to refit up to three heat sinks on your 'mechs. They're much bulkier than regular heat sinks, but they weigh the same and dissipate twice as much heat. Only downside if they're chock full of some really nasty stuff. Makes the Ethylene Glycol the regular ones are fulla look like mother's milk, if you know what I mean...Anyway, it looks like the Combine is bugging out, so I should have plenty of time to mount 'em wherever you want before our next mission. Just lemme know"

BATTLETECH™



MISSIONS

Character _____ Player _____ Cert _____

Mission: 3026-06

Get to the Choppa!

Rough Patch, Barlow's End, Federated Suns

September 31, 3026

Mission Results

- PCs escape with the MacGuffin (Success)
- Macguffin is destroyed or neither side controls it at the end of the scenario (Draw)
- Dragoons escape with the MacGuffin (Failure)
- Opposing 'Mech/Combat Vehicle destroyed by party (+1 XP)

Mech Status

- Mech Survived
- Mech Severely Damaged
- Mech Destroyed

Pilot Status

- Pilot Survived
- Pilot Killed

C-Bill Reward _____ **XP Reward** _____

Salvaged Mechs

- Hornet HNT-151 (1,248,700 C-Bills)
- Firefly FFL-4A (2,203,500 C-Bills)
- Cicada CDA-2A (3,705,217 C-Bills)
- Shadow Hawk SHD-2H (4,539,382 C-Bills)
- Merlin MLN-1A (4,960,000 C-Bills)
- Guillotine GLT-4L (6,062,483 C-Bills)
- Annihilator ANH-1A (7,696,666 C-Bills)
- Archer ARC-2W (6,447,873 C-Bills)

Additional Rewards

Prototype "Freezers":

Don't worry about that green stuff leaking out, it's perfectly safe

The Feds are extremely grateful for our heroes' aid. They've given each PC three prototype double-strength heat sinks (dubbed "Freezers" by the NAIS). These can be refitted to existing Battlemechs. The PC may replace up to three heat sinks in their 'mech. Double strength heat sinks take three critical slots instead of one, so the PC must mark two additional crit slots in the location with the heat sink. Only heat sinks on the record sheet can be replaced, and they cannot be moved.

Additionally, Prototype "Freezer" heat sinks are volatile. If a Freezer is hit it will explode for an additional point of internal structure damage (and an additional "Determine Critical Hit" roll). This does not count as an ammo explosion for purposes of pilot damage.

No 'mech may have more than three prototype Freezers at a time.

GM Signature _____ **Game Date** _____

BATTLETECH™

MISSIONS



Mission: 3026-06 Debrief

Get to the Choppa!

Rough Patch, Barlow's End, Federated Suns

September 31, 3026

You find yourself standing (still in your 'mechs) around the drop port in Rough Patch. You can still see the vapor trails from the retreating dropship with the MacGuffin safely tucked away. The remaining Dragoons' forces have also left the area, having lost all interest in you as soon as their primary objective had escaped.

"So, what the hell was that, anyway?" you ask Dr. Burton, one of the Fed scientists who stayed behind. "Why did the snakes want it so bad? Was it some kind of fancy 'mech weapon or something?"

"Nope" he starts. There's a pause while he clearly thinks about what he's saying, then starts again. "Hell, I might as well tell you, the bad guys already know about it, who are you going to tell? But if you do, you didn't hear it from me. It's a 'Jump Stabilizer.' highly experimental stuff. Basically, you know how Jumpships can only jump about, oh, 30 Light Years or so? Well, it has to do with quantum instabilities in the K/F field. Beyond 30 Light years the field begins to break down and the odds of misjumps increase exponentially. If these guys can make the stabilizer work, they can increase by perhaps as much as a factor of two the safe range of a jump. The military and civilian uses would be incredible. This is stuff even the Star League never imagined"

It's kinda a neat story, actually. You get warm fuzzies just thinking that you might have just saved the technology that could halve the time it takes to cross interstellar empires. Of course, then you think of how terrible it could be. With that sort of technology, the Feds could hit worlds much farther into the Combine (or the Confederation). Border zones would need to be twice as deep, making them much harder to defend. It's actually a bit scary, as well as pretty cool.

Too bad it's all a crock.

You ask Scotty, the Lancers' chief tech about it when you get back to the dropship.

"Hey, did you ever hear about the Manhattan Project? It was the invention of the first atomic weapon by the former North American power called 'USA'. Anyway, it was this top secret project involving hundreds of scientists. Because they didn't want their enemies the Germans to find out what they were doing, they spread a bunch of misinformation about what they were working on – to the extent that the scientists even told their wives that they were 'dehydrogenating water' – to make it easier to carry on the battlefield. Then all they'd need to do is add Hydrogen and – poof, good clean, drinkable water."

Okay, makes sense so far...

"Well, obviously that's stupid. But it sounded good. Same goes with the notion of 'removing instabilities in the K/F field'. The limiting factor of a K/F jump isn't instability or anything like that –

it's about the way that mass affects the shape of spacetime. You calculate the energy required as a function of the mass of the jumping object and an exponential factor of the distance jumped. There's a weird cliff effect at around 30 Light Years. When the mass is negligible, like in a Hyperpulse, then the distance can be much higher. But when the mass is as big as a jumpship, well..."

Bummer.

"Anyway, whatever it was they were making, it's unlikely it had anything to do with jumpships. My guess? They told you a very specific story to see if it gets back to them. Then they'll know they can't trust you. I wouldn't go repeating that story if I were you. You know, unless at some point the Feds really do invent a double-strength jump drive. Then you can tell everyone how instrumental you were in its invention. But I wouldn't hold my breath..."

Well, even if you weren't responsible for the survival of the single greatest technological advance in your lifetime, at least you've got a story about dehydrating water you can tell your buddies back at Barlow's Beginning.

"Oh, hey!" Scotty interrupts you before you can leave. "So, whatever it was, the Feds really wanted it. You see those trucks out there? They've delivered a bunch of toys for you to play with. They're called 'Freezers', and they're the NAIS's attempt at replicating the double strength heat sinks that the Star League was famous for. There's enough for each of you to refit up to three heat sinks on your 'mechs. They're much bulkier than regular heat sinks, but they weigh the same and dissipate twice as much heat. Only downside if they're chock full of some really nasty stuff. Makes the Ethylene Glycol the regular ones are fulla look like mother's milk, if you know what I mean...Anyway, it looks like the Combine is bugging out, so I should have plenty of time to mount 'em wherever you want before our next mission. Just lemme know"

BATTLETECH™



MISSIONS

Character _____ Player _____ Cert _____

Mission: 3026-06

Get to the Choppa!

Rough Patch, Barlow's End, Federated Suns

September 31, 3026

Mission Results

- PCs escape with the MacGuffin (Success)
- Macguffin is destroyed or neither side controls it at the end of the scenario (Draw)
- Dragoons escape with the MacGuffin (Failure)
- Opposing 'Mech/Combat Vehicle destroyed by party (+1 XP)

Mech Status

- Mech Survived
- Mech Severely Damaged
- Mech Destroyed

Pilot Status

- Pilot Survived
- Pilot Killed

C-Bill Reward _____ **XP Reward** _____

Salvaged Mechs

- Hornet HNT-151 (1,248,700 C-Bills)
- Firefly FFL-4A (2,203,500 C-Bills)
- Cicada CDA-2A (3,705,217 C-Bills)
- Shadow Hawk SHD-2H (4,539,382 C-Bills)
- Merlin MLN-1A (4,960,000 C-Bills)
- Guillotine GLT-4L (6,062,483 C-Bills)
- Annihilator ANH-1A (7,696,666 C-Bills)
- Archer ARC-2W (6,447,873 C-Bills)

Additional Rewards

Prototype "Freezers":

Don't worry about that green stuff leaking out, it's perfectly safe

The Feds are extremely grateful for our heroes' aid. They've given each PC three prototype double-strength heat sinks (dubbed "Freezers" by the NAIS). These can be refitted to existing Battlemechs. The PC may replace up to three heat sinks in their 'mech. Double strength heat sinks take three critical slots instead of one, so the PC must mark two additional crit slots in the location with the heat sink. Only heat sinks on the record sheet can be replaced, and they cannot be moved.

Additionally, Prototype "Freezer" heat sinks are volatile. If a Freezer is hit it will explode for an additional point of internal structure damage (and an additional "Determine Critical Hit" roll). This does not count as an ammo explosion for purposes of pilot damage.

No 'mech may have more than three prototype Freezers at a time.

GM Signature _____ **Game Date** _____

BATTLETECH™

MISSIONS



Mission: 3026-06 Debrief

Get to the Choppa!

Rough Patch, Barlow's End, Federated Suns

September 31, 3026

You find yourself standing (still in your 'mechs) around the drop port in Rough Patch. You can still see the vapor trails from the retreating dropship with the MacGuffin safely tucked away. The remaining Dragoons' forces have also left the area, having lost all interest in you as soon as their primary objective had escaped.

"So, what the hell was that, anyway?" you ask Dr. Burton, one of the Fed scientists who stayed behind. "Why did the snakes want it so bad? Was it some kind of fancy 'mech weapon or something?"

"Nope" he starts. There's a pause while he clearly thinks about what he's saying, then starts again. "Hell, I might as well tell you, the bad guys already know about it, who are you going to tell? But if you do, you didn't hear it from me. It's a 'Jump Stabilizer.' highly experimental stuff. Basically, you know how Jumpships can only jump about, oh, 30 Light Years or so? Well, it has to do with quantum instabilities in the K/F field. Beyond 30 Light years the field begins to break down and the odds of misjumps increase exponentially. If these guys can make the stabilizer work, they can increase by perhaps as much as a factor of two the safe range of a jump. The military and civilian uses would be incredible. This is stuff even the Star League never imagined"

It's kinda a neat story, actually. You get warm fuzzies just thinking that you might have just saved the technology that could halve the time it takes to cross interstellar empires. Of course, then you think of how terrible it could be. With that sort of technology, the Feds could hit worlds much farther into the Combine (or the Confederation). Border zones would need to be twice as deep, making them much harder to defend. It's actually a bit scary, as well as pretty cool.

Too bad it's all a crock.

You ask Scotty, the Lancers' chief tech about it when you get back to the dropship.

"Hey, did you ever hear about the Manhattan Project? It was the invention of the first atomic weapon by the former North American power called 'USA'. Anyway, it was this top secret project involving hundreds of scientists. Because they didn't want their enemies the Germans to find out what they were doing, they spread a bunch of misinformation about what they were working on – to the extent that the scientists even told their wives that they were 'dehydrogenating water' – to make it easier to carry on the battlefield. Then all they'd need to do is add Hydrogen and – poof, good clean, drinkable water."

Okay, makes sense so far...

"Well, obviously that's stupid. But it sounded good. Same goes with the notion of 'removing instabilities in the K/F field'. The limiting factor of a K/F jump isn't instability or anything like that –

it's about the way that mass affects the shape of spacetime. You calculate the energy required as a function of the mass of the jumping object and an exponential factor of the distance jumped. There's a weird cliff effect at around 30 Light Years. When the mass is negligible, like in a Hyperpulse, then the distance can be much higher. But when the mass is as big as a jumpship, well..."

Bummer.

"Anyway, whatever it was they were making, it's unlikely it had anything to do with jumpships. My guess? They told you a very specific story to see if it gets back to them. Then they'll know they can't trust you. I wouldn't go repeating that story if I were you. You know, unless at some point the Feds really do invent a double-strength jump drive. Then you can tell everyone how instrumental you were in its invention. But I wouldn't hold my breath..."

Well, even if you weren't responsible for the survival of the single greatest technological advance in your lifetime, at least you've got a story about dehydrating water you can tell your buddies back at Barlow's Beginning.

"Oh, hey!" Scotty interrupts you before you can leave. "So, whatever it was, the Feds really wanted it. You see those trucks out there? They've delivered a bunch of toys for you to play with. They're called 'Freezers', and they're the NAIS's attempt at replicating the double strength heat sinks that the Star League was famous for. There's enough for each of you to refit up to three heat sinks on your 'mechs. They're much bulkier than regular heat sinks, but they weigh the same and dissipate twice as much heat. Only downside if they're chock full of some really nasty stuff. Makes the Ethylene Glycol the regular ones are fulla look like mother's milk, if you know what I mean...Anyway, it looks like the Combine is bugging out, so I should have plenty of time to mount 'em wherever you want before our next mission. Just lemme know"

BATTLETECH™



MISSIONS

Character _____ Player _____ Cert _____

Mission: 3026-06

Get to the Choppa!

Rough Patch, Barlow's End, Federated Suns

September 31, 3026

Mission Results

- PCs escape with the MacGuffin (Success)
- Macguffin is destroyed or neither side controls it at the end of the scenario (Draw)
- Dragoons escape with the MacGuffin (Failure)
- Opposing 'Mech/Combat Vehicle destroyed by party (+1 XP)

Mech Status

- Mech Survived
- Mech Severely Damaged
- Mech Destroyed

Pilot Status

- Pilot Survived
- Pilot Killed

C-Bill Reward _____ **XP Reward** _____

Salvaged Mechs

- Hornet HNT-151 (1,248,700 C-Bills)
- Firefly FFL-4A (2,203,500 C-Bills)
- Cicada CDA-2A (3,705,217 C-Bills)
- Shadow Hawk SHD-2H (4,539,382 C-Bills)
- Merlin MLN-1A (4,960,000 C-Bills)
- Guillotine GLT-4L (6,062,483 C-Bills)
- Annihilator ANH-1A (7,696,666 C-Bills)
- Archer ARC-2W (6,447,873 C-Bills)

Additional Rewards

Prototype "Freezers":

Don't worry about that green stuff leaking out, it's perfectly safe

The Feds are extremely grateful for our heroes' aid. They've given each PC three prototype double-strength heat sinks (dubbed "Freezers" by the NAIS). These can be refitted to existing Battlemechs. The PC may replace up to three heat sinks in their 'mech. Double strength heat sinks take three critical slots instead of one, so the PC must mark two additional crit slots in the location with the heat sink. Only heat sinks on the record sheet can be replaced, and they cannot be moved.

Additionally, Prototype "Freezer" heat sinks are volatile. If a Freezer is hit it will explode for an additional point of internal structure damage (and an additional "Determine Critical Hit" roll). This does not count as an ammo explosion for purposes of pilot damage.

No 'mech may have more than three prototype Freezers at a time.

GM Signature _____ **Game Date** _____

BATTLETECH™

MISSIONS



Mission: 3026-06 Debrief

Get to the Choppa!

Rough Patch, Barlow's End, Federated Suns

September 31, 3026

You find yourself standing (still in your 'mechs) around the drop port in Rough Patch. You can still see the vapor trails from the retreating dropship with the MacGuffin safely tucked away. The remaining Dragoons' forces have also left the area, having lost all interest in you as soon as their primary objective had escaped.

"So, what the hell was that, anyway?" you ask Dr. Burton, one of the Fed scientists who stayed behind. "Why did the snakes want it so bad? Was it some kind of fancy 'mech weapon or something?"

"Nope" he starts. There's a pause while he clearly thinks about what he's saying, then starts again. "Hell, I might as well tell you, the bad guys already know about it, who are you going to tell? But if you do, you didn't hear it from me. It's a 'Jump Stabilizer.' highly experimental stuff. Basically, you know how Jumpships can only jump about, oh, 30 Light Years or so? Well, it has to do with quantum instabilities in the K/F field. Beyond 30 Light years the field begins to break down and the odds of misjumps increase exponentially. If these guys can make the stabilizer work, they can increase by perhaps as much as a factor of two the safe range of a jump. The military and civilian uses would be incredible. This is stuff even the Star League never imagined"

It's kinda a neat story, actually. You get warm fuzzies just thinking that you might have just saved the technology that could halve the time it takes to cross interstellar empires. Of course, then you think of how terrible it could be. With that sort of technology, the Feds could hit worlds much farther into the Combine (or the Confederation). Border zones would need to be twice as deep, making them much harder to defend. It's actually a bit scary, as well as pretty cool.

Too bad it's all a crock.

You ask Scotty, the Lancers' chief tech about it when you get back to the dropship.

"Hey, did you ever hear about the Manhattan Project? It was the invention of the first atomic weapon by the former North American power called 'USA'. Anyway, it was this top secret project involving hundreds of scientists. Because they didn't want their enemies the Germans to find out what they were doing, they spread a bunch of misinformation about what they were working on – to the extent that the scientists even told their wives that they were 'dehydrogenating water' – to make it easier to carry on the battlefield. Then all they'd need to do is add Hydrogen and – poof, good clean, drinkable water."

Okay, makes sense so far...

"Well, obviously that's stupid. But it sounded good. Same goes with the notion of 'removing instabilities in the K/F field'. The limiting factor of a K/F jump isn't instability or anything like that –

it's about the way that mass affects the shape of spacetime. You calculate the energy required as a function of the mass of the jumping object and an exponential factor of the distance jumped. There's a weird cliff effect at around 30 Light Years. When the mass is negligible, like in a Hyperpulse, then the distance can be much higher. But when the mass is as big as a jumpship, well..."

Bummer.

"Anyway, whatever it was they were making, it's unlikely it had anything to do with jumpships. My guess? They told you a very specific story to see if it gets back to them. Then they'll know they can't trust you. I wouldn't go repeating that story if I were you. You know, unless at some point the Feds really do invent a double-strength jump drive. Then you can tell everyone how instrumental you were in its invention. But I wouldn't hold my breath..."

Well, even if you weren't responsible for the survival of the single greatest technological advance in your lifetime, at least you've got a story about dehydrating water you can tell your buddies back at Barlow's Beginning.

"Oh, hey!" Scotty interrupts you before you can leave. "So, whatever it was, the Feds really wanted it. You see those trucks out there? They've delivered a bunch of toys for you to play with. They're called 'Freezers', and they're the NAIS's attempt at replicating the double strength heat sinks that the Star League was famous for. There's enough for each of you to refit up to three heat sinks on your 'mechs. They're much bulkier than regular heat sinks, but they weigh the same and dissipate twice as much heat. Only downside if they're chock full of some really nasty stuff. Makes the Ethylene Glycol the regular ones are fulla look like mother's milk, if you know what I mean...Anyway, it looks like the Combine is bugging out, so I should have plenty of time to mount 'em wherever you want before our next mission. Just lemme know"

BATTLETECH™



MISSIONS

Character _____ Player _____ Cert _____

Mission: 3026-06

Get to the Choppa!

Rough Patch, Barlow's End, Federated Suns

September 31, 3026

Mission Results

- PCs escape with the MacGuffin (Success)
- Macguffin is destroyed or neither side controls it at the end of the scenario (Draw)
- Dragoons escape with the MacGuffin (Failure)
- Opposing 'Mech/Combat Vehicle destroyed by party (+1 XP)

Mech Status

- Mech Survived
- Mech Severely Damaged
- Mech Destroyed

Pilot Status

- Pilot Survived
- Pilot Killed

C-Bill Reward _____ **XP Reward** _____

Salvaged Mechs

- Hornet HNT-151 (1,248,700 C-Bills)
- Firefly FFL-4A (2,203,500 C-Bills)
- Cicada CDA-2A (3,705,217 C-Bills)
- Shadow Hawk SHD-2H (4,539,382 C-Bills)
- Merlin MLN-1A (4,960,000 C-Bills)
- Guillotine GLT-4L (6,062,483 C-Bills)
- Annihilator ANH-1A (7,696,666 C-Bills)
- Archer ARC-2W (6,447,873 C-Bills)

Additional Rewards

Prototype "Freezers":

Don't worry about that green stuff leaking out, it's perfectly safe

The Feds are extremely grateful for our heroes' aid. They've given each PC three prototype double-strength heat sinks (dubbed "Freezers" by the NAIS). These can be refitted to existing Battlemechs. The PC may replace up to three heat sinks in their 'mech. Double strength heat sinks take three critical slots instead of one, so the PC must mark two additional crit slots in the location with the heat sink. Only heat sinks on the record sheet can be replaced, and they cannot be moved.

Additionally, Prototype "Freezer" heat sinks are volatile. If a Freezer is hit it will explode for an additional point of internal structure damage (and an additional "Determine Critical Hit" roll). This does not count as an ammo explosion for purposes of pilot damage.

No 'mech may have more than three prototype Freezers at a time.

GM Signature _____ **Game Date** _____

BATTLETECH™

MISSIONS



Mission: 3026-06 Debrief

Get to the Choppa!

Rough Patch, Barlow's End, Federated Suns

September 31, 3026

You find yourself standing (still in your 'mechs) around the drop port in Rough Patch. You can still see the vapor trails from the retreating dropship with the MacGuffin safely tucked away. The remaining Dragoons' forces have also left the area, having lost all interest in you as soon as their primary objective had escaped.

"So, what the hell was that, anyway?" you ask Dr. Burton, one of the Fed scientists who stayed behind. "Why did the snakes want it so bad? Was it some kind of fancy 'mech weapon or something?"

"Nope" he starts. There's a pause while he clearly thinks about what he's saying, then starts again. "Hell, I might as well tell you, the bad guys already know about it, who are you going to tell? But if you do, you didn't hear it from me. It's a 'Jump Stabilizer.' highly experimental stuff. Basically, you know how Jumpships can only jump about, oh, 30 Light Years or so? Well, it has to do with quantum instabilities in the K/F field. Beyond 30 Light years the field begins to break down and the odds of misjumps increase exponentially. If these guys can make the stabilizer work, they can increase by perhaps as much as a factor of two the safe range of a jump. The military and civilian uses would be incredible. This is stuff even the Star League never imagined"

It's kinda a neat story, actually. You get warm fuzzies just thinking that you might have just saved the technology that could halve the time it takes to cross interstellar empires. Of course, then you think of how terrible it could be. With that sort of technology, the Feds could hit worlds much farther into the Combine (or the Confederation). Border zones would need to be twice as deep, making them much harder to defend. It's actually a bit scary, as well as pretty cool.

Too bad it's all a crock.

You ask Scotty, the Lancers' chief tech about it when you get back to the dropship.

"Hey, did you ever hear about the Manhattan Project? It was the invention of the first atomic weapon by the former North American power called 'USA'. Anyway, it was this top secret project involving hundreds of scientists. Because they didn't want their enemies the Germans to find out what they were doing, they spread a bunch of misinformation about what they were working on – to the extent that the scientists even told their wives that they were 'dehydrogenating water' – to make it easier to carry on the battlefield. Then all they'd need to do is add Hydrogen and – poof, good clean, drinkable water."

Okay, makes sense so far...

"Well, obviously that's stupid. But it sounded good. Same goes with the notion of 'removing instabilities in the K/F field'. The limiting factor of a K/F jump isn't instability or anything like that –

it's about the way that mass affects the shape of spacetime. You calculate the energy required as a function of the mass of the jumping object and an exponential factor of the distance jumped. There's a weird cliff effect at around 30 Light Years. When the mass is negligible, like in a Hyperpulse, then the distance can be much higher. But when the mass is as big as a jumpship, well..."

Bummer.

"Anyway, whatever it was they were making, it's unlikely it had anything to do with jumpships. My guess? They told you a very specific story to see if it gets back to them. Then they'll know they can't trust you. I wouldn't go repeating that story if I were you. You know, unless at some point the Feds really do invent a double-strength jump drive. Then you can tell everyone how instrumental you were in its invention. But I wouldn't hold my breath..."

Well, even if you weren't responsible for the survival of the single greatest technological advance in your lifetime, at least you've got a story about dehydrating water you can tell your buddies back at Barlow's Beginning.

"Oh, hey!" Scotty interrupts you before you can leave. "So, whatever it was, the Feds really wanted it. You see those trucks out there? They've delivered a bunch of toys for you to play with. They're called 'Freezers', and they're the NAIS's attempt at replicating the double strength heat sinks that the Star League was famous for. There's enough for each of you to refit up to three heat sinks on your 'mechs. They're much bulkier than regular heat sinks, but they weigh the same and dissipate twice as much heat. Only downside if they're chock full of some really nasty stuff. Makes the Ethylene Glycol the regular ones are fulla look like mother's milk, if you know what I mean...Anyway, it looks like the Combine is bugging out, so I should have plenty of time to mount 'em wherever you want before our next mission. Just lemme know"

BATTLETECH™



MISSIONS

Character _____ Player _____ Cert _____

Mission: 3026-06

Get to the Choppa!

Rough Patch, Barlow's End, Federated Suns

September 31, 3026

Mission Results

- PCs escape with the MacGuffin (Success)
- Macguffin is destroyed or neither side controls it at the end of the scenario (Draw)
- Dragoons escape with the MacGuffin (Failure)
- Opposing 'Mech/Combat Vehicle destroyed by party (+1 XP)

Mech Status

- Mech Survived
- Mech Severely Damaged
- Mech Destroyed

Pilot Status

- Pilot Survived
- Pilot Killed

C-Bill Reward _____ **XP Reward** _____

Salvaged Mechs

- Hornet HNT-151 (1,248,700 C-Bills)
- Firefly FFL-4A (2,203,500 C-Bills)
- Cicada CDA-2A (3,705,217 C-Bills)
- Shadow Hawk SHD-2H (4,539,382 C-Bills)
- Merlin MLN-1A (4,960,000 C-Bills)
- Guillotine GLT-4L (6,062,483 C-Bills)
- Annihilator ANH-1A (7,696,666 C-Bills)
- Archer ARC-2W (6,447,873 C-Bills)

Additional Rewards

Prototype "Freezers":

Don't worry about that green stuff leaking out, it's perfectly safe

The Feds are extremely grateful for our heroes' aid. They've given each PC three prototype double-strength heat sinks (dubbed "Freezers" by the NAIS). These can be refitted to existing Battlemechs. The PC may replace up to three heat sinks in their 'mech. Double strength heat sinks take three critical slots instead of one, so the PC must mark two additional crit slots in the location with the heat sink. Only heat sinks on the record sheet can be replaced, and they cannot be moved.

Additionally, Prototype "Freezer" heat sinks are volatile. If a Freezer is hit it will explode for an additional point of internal structure damage (and an additional "Determine Critical Hit" roll). This does not count as an ammo explosion for purposes of pilot damage.

No 'mech may have more than three prototype Freezers at a time.

GM Signature _____ **Game Date** _____

BATTLETECH™

MISSIONS



Mission: 3026-06 Debrief

Get to the Choppa!

Rough Patch, Barlow's End, Federated Suns

September 31, 3026

You find yourself standing (still in your 'mechs) around the drop port in Rough Patch. You can still see the vapor trails from the retreating dropship with the MacGuffin safely tucked away. The remaining Dragoons' forces have also left the area, having lost all interest in you as soon as their primary objective had escaped.

"So, what the hell was that, anyway?" you ask Dr. Burton, one of the Fed scientists who stayed behind. "Why did the snakes want it so bad? Was it some kind of fancy 'mech weapon or something?"

"Nope" he starts. There's a pause while he clearly thinks about what he's saying, then starts again. "Hell, I might as well tell you, the bad guys already know about it, who are you going to tell? But if you do, you didn't hear it from me. It's a 'Jump Stabilizer.' highly experimental stuff. Basically, you know how Jumpships can only jump about, oh, 30 Light Years or so? Well, it has to do with quantum instabilities in the K/F field. Beyond 30 Light years the field begins to break down and the odds of misjumps increase exponentially. If these guys can make the stabilizer work, they can increase by perhaps as much as a factor of two the safe range of a jump. The military and civilian uses would be incredible. This is stuff even the Star League never imagined"

It's kinda a neat story, actually. You get warm fuzzies just thinking that you might have just saved the technology that could halve the time it takes to cross interstellar empires. Of course, then you think of how terrible it could be. With that sort of technology, the Feds could hit worlds much farther into the Combine (or the Confederation). Border zones would need to be twice as deep, making them much harder to defend. It's actually a bit scary, as well as pretty cool.

Too bad it's all a crock.

You ask Scotty, the Lancers' chief tech about it when you get back to the dropship.

"Hey, did you ever hear about the Manhattan Project? It was the invention of the first atomic weapon by the former North American power called 'USA'. Anyway, it was this top secret project involving hundreds of scientists. Because they didn't want their enemies the Germans to find out what they were doing, they spread a bunch of misinformation about what they were working on – to the extent that the scientists even told their wives that they were 'dehydrogenating water' – to make it easier to carry on the battlefield. Then all they'd need to do is add Hydrogen and – poof, good clean, drinkable water."

Okay, makes sense so far...

"Well, obviously that's stupid. But it sounded good. Same goes with the notion of 'removing instabilities in the K/F field'. The limiting factor of a K/F jump isn't instability or anything like that –

it's about the way that mass affects the shape of spacetime. You calculate the energy required as a function of the mass of the jumping object and an exponential factor of the distance jumped. There's a weird cliff effect at around 30 Light Years. When the mass is negligible, like in a Hyperpulse, then the distance can be much higher. But when the mass is as big as a jumpship, well..."

Bummer.

"Anyway, whatever it was they were making, it's unlikely it had anything to do with jumpships. My guess? They told you a very specific story to see if it gets back to them. Then they'll know they can't trust you. I wouldn't go repeating that story if I were you. You know, unless at some point the Feds really do invent a double-strength jump drive. Then you can tell everyone how instrumental you were in its invention. But I wouldn't hold my breath..."

Well, even if you weren't responsible for the survival of the single greatest technological advance in your lifetime, at least you've got a story about dehydrating water you can tell your buddies back at Barlow's Beginning.

"Oh, hey!" Scotty interrupts you before you can leave. "So, whatever it was, the Feds really wanted it. You see those trucks out there? They've delivered a bunch of toys for you to play with. They're called 'Freezers', and they're the NAIS's attempt at replicating the double strength heat sinks that the Star League was famous for. There's enough for each of you to refit up to three heat sinks on your 'mechs. They're much bulkier than regular heat sinks, but they weigh the same and dissipate twice as much heat. Only downside if they're chock full of some really nasty stuff. Makes the Ethylene Glycol the regular ones are fulla look like mother's milk, if you know what I mean...Anyway, it looks like the Combine is bugging out, so I should have plenty of time to mount 'em wherever you want before our next mission. Just lemme know"

BATTLETECH™



MISSIONS

Character _____ Player _____ Cert _____

Mission: 3026-06

Get to the Choppa!

Rough Patch, Barlow's End, Federated Suns

September 31, 3026

Mission Results

- PCs escape with the MacGuffin (Success)
- Macguffin is destroyed or neither side controls it at the end of the scenario (Draw)
- Dragoons escape with the MacGuffin (Failure)
- Opposing 'Mech/Combat Vehicle destroyed by party (+1 XP)

Mech Status

- Mech Survived
- Mech Severely Damaged
- Mech Destroyed

Pilot Status

- Pilot Survived
- Pilot Killed

C-Bill Reward _____ **XP Reward** _____

Salvaged Mechs

- Hornet HNT-151 (1,248,700 C-Bills)
- Firefly FFL-4A (2,203,500 C-Bills)
- Cicada CDA-2A (3,705,217 C-Bills)
- Shadow Hawk SHD-2H (4,539,382 C-Bills)
- Merlin MLN-1A (4,960,000 C-Bills)
- Guillotine GLT-4L (6,062,483 C-Bills)
- Annihilator ANH-1A (7,696,666 C-Bills)
- Archer ARC-2W (6,447,873 C-Bills)

Additional Rewards

Prototype "Freezers":

Don't worry about that green stuff leaking out, it's perfectly safe

The Feds are extremely grateful for our heroes' aid. They've given each PC three prototype double-strength heat sinks (dubbed "Freezers" by the NAIS). These can be refitted to existing Battlemechs. The PC may replace up to three heat sinks in their 'mech. Double strength heat sinks take three critical slots instead of one, so the PC must mark two additional crit slots in the location with the heat sink. Only heat sinks on the record sheet can be replaced, and they cannot be moved.

Additionally, Prototype "Freezer" heat sinks are volatile. If a Freezer is hit it will explode for an additional point of internal structure damage (and an additional "Determine Critical Hit" roll). This does not count as an ammo explosion for purposes of pilot damage.

No 'mech may have more than three prototype Freezers at a time.

GM Signature _____ **Game Date** _____

BATTLETECH™

MISSIONS



Mission: 3026-06 Debrief

Get to the Choppa!

Rough Patch, Barlow's End, Federated Suns

September 31, 3026

You find yourself standing (still in your 'mechs) around the drop port in Rough Patch. You can still see the vapor trails from the retreating dropship with the MacGuffin safely tucked away. The remaining Dragoons' forces have also left the area, having lost all interest in you as soon as their primary objective had escaped.

"So, what the hell was that, anyway?" you ask Dr. Burton, one of the Fed scientists who stayed behind. "Why did the snakes want it so bad? Was it some kind of fancy 'mech weapon or something?"

"Nope" he starts. There's a pause while he clearly thinks about what he's saying, then starts again. "Hell, I might as well tell you, the bad guys already know about it, who are you going to tell? But if you do, you didn't hear it from me. It's a 'Jump Stabilizer.' highly experimental stuff. Basically, you know how Jumpships can only jump about, oh, 30 Light Years or so? Well, it has to do with quantum instabilities in the K/F field. Beyond 30 Light years the field begins to break down and the odds of misjumps increase exponentially. If these guys can make the stabilizer work, they can increase by perhaps as much as a factor of two the safe range of a jump. The military and civilian uses would be incredible. This is stuff even the Star League never imagined"

It's kinda a neat story, actually. You get warm fuzzies just thinking that you might have just saved the technology that could halve the time it takes to cross interstellar empires. Of course, then you think of how terrible it could be. With that sort of technology, the Feds could hit worlds much farther into the Combine (or the Confederation). Border zones would need to be twice as deep, making them much harder to defend. It's actually a bit scary, as well as pretty cool.

Too bad it's all a crock.

You ask Scotty, the Lancers' chief tech about it when you get back to the dropship.

"Hey, did you ever hear about the Manhattan Project? It was the invention of the first atomic weapon by the former North American power called 'USA'. Anyway, it was this top secret project involving hundreds of scientists. Because they didn't want their enemies the Germans to find out what they were doing, they spread a bunch of misinformation about what they were working on – to the extent that the scientists even told their wives that they were 'dehydrogenating water' – to make it easier to carry on the battlefield. Then all they'd need to do is add Hydrogen and – poof, good clean, drinkable water."

Okay, makes sense so far...

"Well, obviously that's stupid. But it sounded good. Same goes with the notion of 'removing instabilities in the K/F field'. The limiting factor of a K/F jump isn't instability or anything like that –

it's about the way that mass affects the shape of spacetime. You calculate the energy required as a function of the mass of the jumping object and an exponential factor of the distance jumped. There's a weird cliff effect at around 30 Light Years. When the mass is negligible, like in a Hyperpulse, then the distance can be much higher. But when the mass is as big as a jumpship, well..."

Bummer.

"Anyway, whatever it was they were making, it's unlikely it had anything to do with jumpships. My guess? They told you a very specific story to see if it gets back to them. Then they'll know they can't trust you. I wouldn't go repeating that story if I were you. You know, unless at some point the Feds really do invent a double-strength jump drive. Then you can tell everyone how instrumental you were in its invention. But I wouldn't hold my breath..."

Well, even if you weren't responsible for the survival of the single greatest technological advance in your lifetime, at least you've got a story about dehydrating water you can tell your buddies back at Barlow's Beginning.

"Oh, hey!" Scotty interrupts you before you can leave. "So, whatever it was, the Feds really wanted it. You see those trucks out there? They've delivered a bunch of toys for you to play with. They're called 'Freezers', and they're the NAIS's attempt at replicating the double strength heat sinks that the Star League was famous for. There's enough for each of you to refit up to three heat sinks on your 'mechs. They're much bulkier than regular heat sinks, but they weigh the same and dissipate twice as much heat. Only downside if they're chock full of some really nasty stuff. Makes the Ethylene Glycol the regular ones are fulla look like mother's milk, if you know what I mean...Anyway, it looks like the Combine is bugging out, so I should have plenty of time to mount 'em wherever you want before our next mission. Just lemme know"

GM Report
Mission 3026-06 - Get to the Choppa!

Date: _____

GM: _____

Venue _____

Player	Player #	Mech (Variant)	Pilot Skill (G/P)	BV	C-Bill Reward	XP Reward
1						
2						
3						
4						
5						
6						
7						
8						

Salvaged Mechs

- Hornet HNT-151 (1,248,700 C-Bills)
- Firefly FFL-4A (2,203,500 C-Bills)
- Cicada CDA-2A (3,705,217 C-Bills)
- Shadow Hawk SHD-2H (4,539,382 C-Bills)
- Merlin MLN-1A (4,960,000 C-Bills)
- Guillotine GLT-4L (6,062,483 C-Bills)
- Annihilator ANH-1A (7,696,666 C-Bills)
- Archer ARC-2W (6,447,873 C-Bills)

GUNNERY	PILOTING/DRIVING/ANTI-MECH								
	0	1	2	3	4	5	6	7	8
0	2.42	2.31	2.21	2.10	1.93	1.75	1.68	1.59	1.50
1	2.21	2.11	2.02	1.92	1.76	1.60	1.54	1.46	1.38
2	1.93	1.85	1.76	1.68	1.54	1.40	1.35	1.28	1.21
3	1.66	1.58	1.51	1.44	1.32	1.20	1.16	1.10	1.04
4	1.38	1.32	1.26	1.20	1.10	1.00	0.95	0.90	0.85
5	1.31	1.19	1.13	1.08	0.99	0.90	0.86	0.81	0.77
6	1.24	1.12	1.07	1.02	0.94	0.85	0.81	0.77	0.72
7	1.17	1.06	1.01	0.96	0.88	0.80	0.76	0.72	0.68
8	1.10	0.99	0.95	0.90	0.83	0.75	0.71	0.68	0.64